

Company profile

Weidmüller is the leading manufacturer of components for electrical and electronic interconnection technologies.

The company develops, produces and sells customer-oriented solutions comprising the entire Weidmüller product portfolio. As an OEM supplier, the company sets global standards in the field of electrical connection technology.

The Weidmüller product portfolio ranges from terminal blocks, PCB connectors and terminals, protected components, Industrial Ethernet components and relay sockets to power supply and overvoltage protection modules suitable for all applications. Electrical installation and marking solutions, basic I/O components and a variety of tools round off the range. Weidmüller products are mainly used in control cabinets and for field wiring. Customers also benefit from our wide range of services.

In addition to our expertise in manufacturing precision mechanics, we offer a customer oriented product portfolio for our international customers in the fields of industrial, process and transportation technology. Our developments and activities are driven solely by the individual requirements of our customers in these areas.

The Weidmüller Group has a strong international orientation with production facilities, sales companies and agencies in over 70 countries. Due to our high standards of quality and service, customers around the world value us as a highly competent and flexible partner.

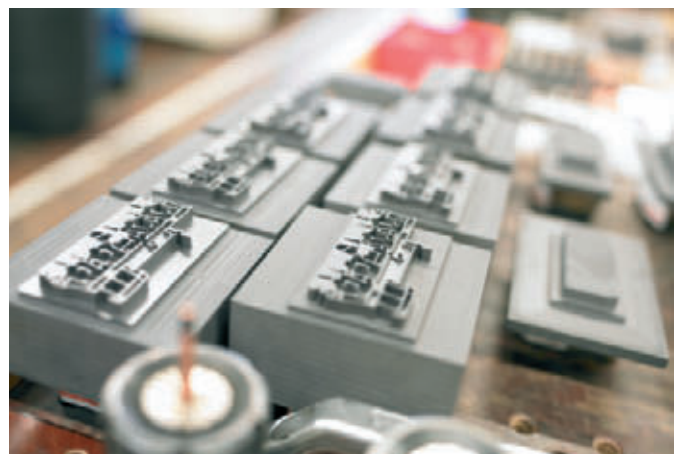

All the catalogues at a glance

Catalogue 1: Modular Terminal Blocks

Order number: 5650110000

- P-Series (Push In technology)
- I-Series (IDC technology)
- Z-Series (Tension clamp technology)
- W-Series (Screw connection technology)
- Stud style (Screw connection technology)



Catalogue 2: PCB Terminals and Connectors

Order number: 5650120000

PCB Terminals with

- leaf spring connection, clamping yoke connection, TOP clamp connection, tension clamp connection, Push In spring connection, spade connection

PCB Connectors of

- Minimate, Omnimate, Unimate, Powermate and Crimpmate Ranges



Catalogue 3: RockStar® – Heavy Duty Connectors

Order number: 5650130000

- Inserts
- Modular system
- Housings IP65 + IP69K



Catalogue 4: Electronics

Order number: 5650140000

- Interface units
- Digital signal processing
- Analogue signal processing
- Power supplies
- Overvoltage protection



Catalogue 5: Enclosures and Cable Glands

Order number: 5650150000

- Enclosures
- Cable gland and Cabtite



Catalogue 6: Tools

Order number: 5650160000

- Cutting
- Stripping
- Crimping
- Screwdrivers
- Measuring/Testing
- Automatic machines



Catalogue 7: Marking Systems

Order number: 5650170000

- Terminal markers
- Wire and cable markers
- Device and equipment markers
- Printing systems
- Software



Catalogue 8: Sensor Actuator Interface

Order number: 5650180000

- SAI Passive
- SAI Active
- Cables and connectors
- JACKPAC® IP67



Catalogue 9: Industrial Ethernet

Order number: 5650190000

- Active components
- Passive components
- Accessories



Complete Set

Order number: 5650100000

- composed of catalogue 1 to catalogue 9 inclusive



Online Catalogue

If you have questions about the specifications and details of our products, perhaps even outside normal business hours, then our online catalogue at <http://catalog.weidmueller.com> – open 24 hours a day, 365 days a year – is the perfect source of information. Besides product features and part numbers, it contains extensive additional information on all product groups. And for further information, offers and your personal contact, simply consult the Weidmüller website at www.weidmueller.com.

CD-ROM

As well as browsing through our printed and online catalogues you can now gain an overview of our products with the help of our CD-ROM. You don't need Internet access nor do you have to install the CD. Simply insert the CD-ROM into the drive and browse away.

The world of connection technology

Control / PLC



**Catalogue 1
Modular Terminal
Blocks**

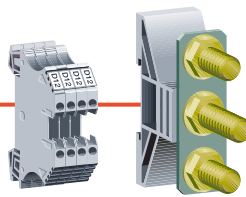

- Modular Terminal Blocks**
- Push In technology
 - IDC technology
 - Tension clamp technology
 - Screw connection technology
- Stud style**

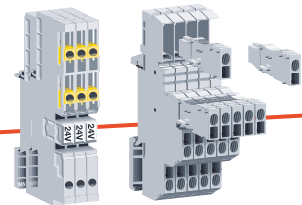

- Tools**
- Cutting, stripping, crimping, screwdrivers, measuring / testing
 - Automatic machines



**Catalogue 6
Tools**

**Catalogue 3
RockStar® –
Heavy Duty Connectors**

- Heavy Duty Connectors**
- Inserts
 - Modular system
 - Housings IP65 + IP69K

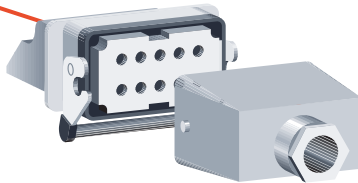

- Marking systems**
- Terminal-, wire and cable, device and equipment markers
 - Printing systems
 - Software

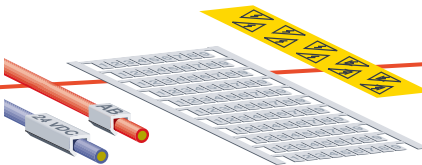

**Catalogue 7
Marking Systems**

**Catalogue 5
Enclosures and
Cable Glands**

- Enclosures,
Cable glands,
Cabtite**

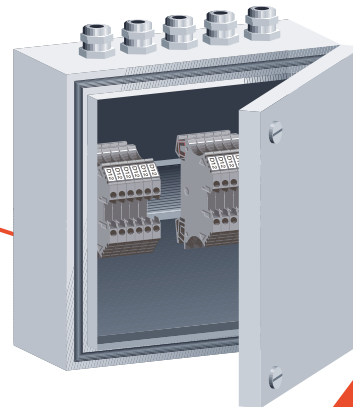

- Sensor Actuator Interface**
- SAI Passive
 - SAI Active
 - Cable and connectors
 - JACKPAC® IP67

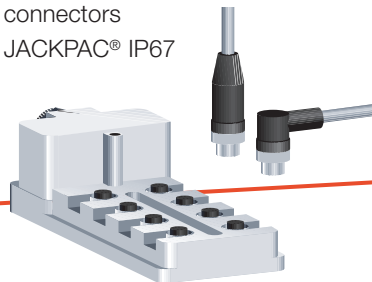

**Catalogue 8
Sensor Actuator Interface**

Sensors / Actuators

Introduction	Introduction	A
PCB Terminals	PCB Terminals	B
PCB Connectors	Overview of PCB Connectors	C
	Minimate Range pitch 3.50	D
	Omnimate Range pitch 3.50 / 3.81	E
	Omnimate Range pitch 5.00 / 5.08	F
	Omnimate Range pitch 7.50 / 7.62	G
	Unimate Range pitch 5.08	H
	Powermate Range pitch 7.00	I
	Powermate Range pitch 7.62	J
	Powermate Range pitch 10.16	K
	Crimpmate Range pitch 5.00	L
Electronics housings	Electronics housings	M
Accessories	Accessories	N
Appendix	Weidmüller Service	V
	Technical appendix	W
	Index Search according to type or order number, worldwide activities	X

PCB Terminals and Connectors

Clamping yoke connection $\leq 6 \text{ mm}^2$

Page B.2

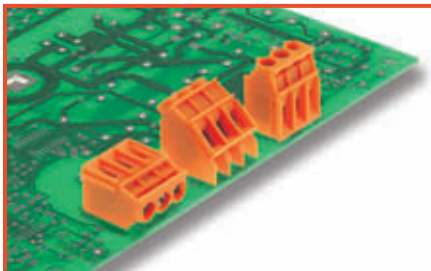

Clamping yoke connection $> 6 \text{ mm}^2$

Page B.32

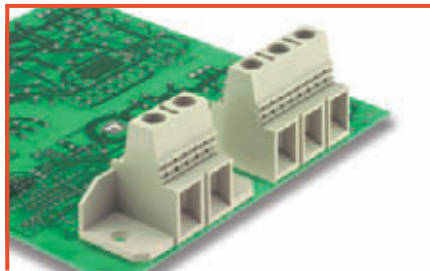

TOP connection

Page B.44

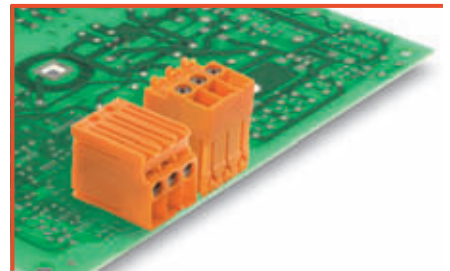

Leaf spring connection

Page B.58

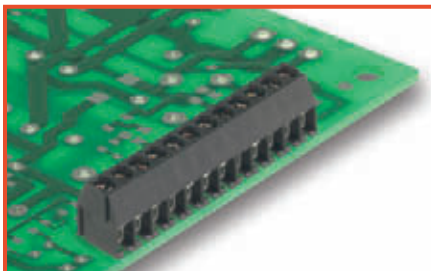

Tension clamp connection

Page B.62

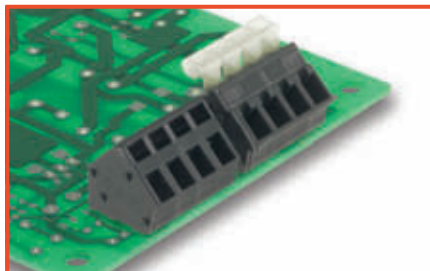

Spade connection

Page B.66

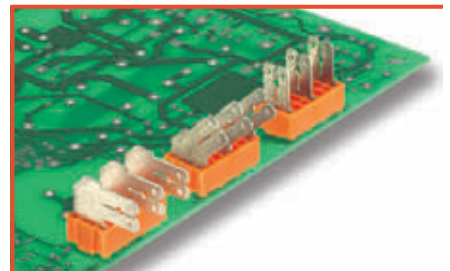

THR clamping yoke connection

Page B.72

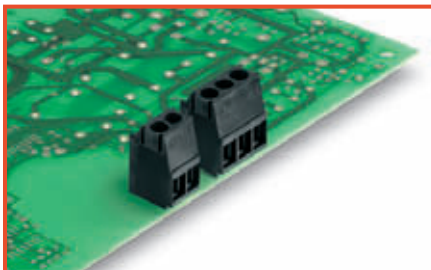

THR with push-in connection

Page B.76

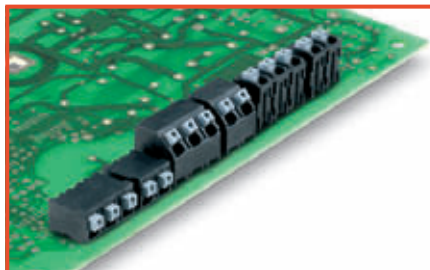

Minimate Range pitch 3.50 mm

Page D.2

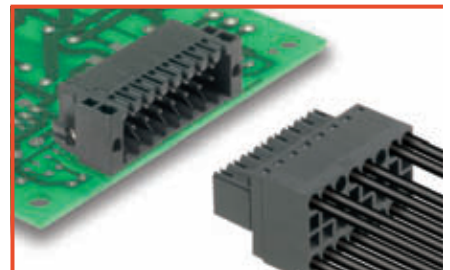

Omnimate Range pitch 3.50 mm

Page E.2

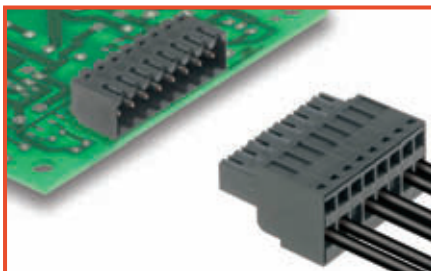

Omnimate Range pitch 3.81 mm

Page E.48

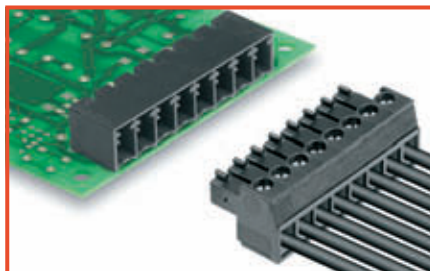

Omnimate Range pitch 5.00/5.08 mm

Page F.2

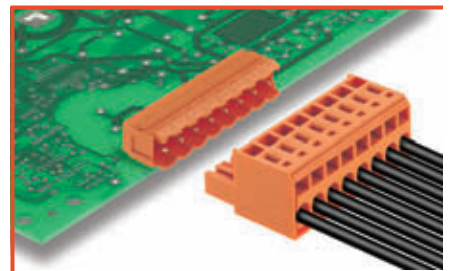

Omnimate Range pitch 7.50/7.62 mm

Page G.2

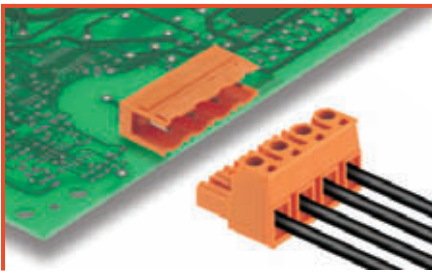

Unimate Range pitch 5.08 mm

Page H.2

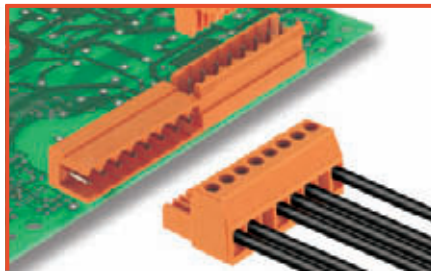

Powermate Range STV

Page I.2



Powermate Range SV/BV

Page J.2

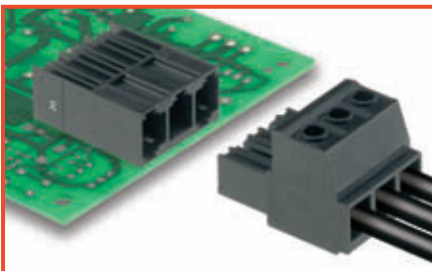

Powermate Range SU/BU

Page K.2

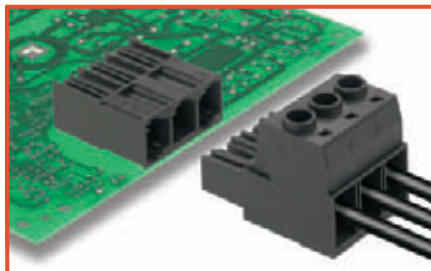

Crimpmate Range pitch 5.00 mm

Page L.2



Electronics housings

Page M.4



Installation housings in profile form

Page M.14

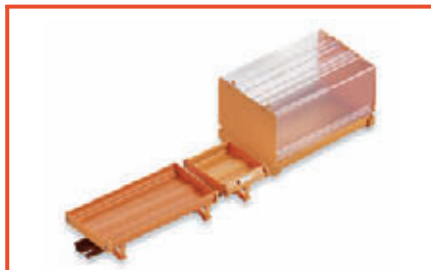

Housings in terminal form

Page M.18



PCB Terminals

PCB Terminals

Clamping yoke connection for cross-sections up to 1.5 mm ²	B.2
Clamping yoke connection for cross-sections up to 2.5 mm ²	B.8
Clamping yoke connection for cross-sections up to 6 mm ²	B.14
Clamping yoke connection for cross-sections up to 10 mm ²	B.32
Clamping yoke connection for cross-sections up to 16 mm ²	B.34
Clamping yoke connection for cross-sections up to 25 mm ²	B.40
TOP connection	B.44
Leaf spring connection	B.58
Tension clamp connection	B.62
Spade connection	B.66
THR PCB Terminals with clamping yoke connection	B.72
THR PCB Terminals with push-in connection	B.76

LM 3.5/135

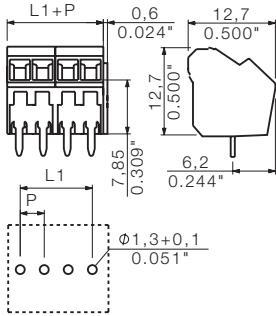

Accessories

Possible colors

Additional colours on request



Marking strips

See chapter accessories



Screwdriver

See chapter accessories
Order No. 9008370000



Ordering data

Solder pin length	3.2 mm
Colour	orange

Pitch 3.50 mm

Poles	L1 mm	(inch)	Qty.	Order No.	Order No.
2	3.50	(0.138)	100		1714980000
3	7.00	(0.276)	100		1715020000
4	10.50	(0.413)	100		1845220000
5	14.00	(0.551)	50		1845230000
6	17.50	(0.689)	50		1845240000
7	21.00	(0.827)	50		1845250000
8	24.50	(0.965)	50		1845260000
9	28.00	(1.102)	50		1845270000
10	31.50	(1.240)	50		1845280000
11	35.00	(1.378)	50		1845290000
12	38.50	(1.516)	50		1845300000

LM2N 3.5

Multi level

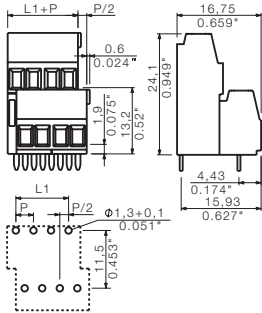

Accessories

Possible colors

Additional colours on request



Marking strips

See chapter accessories



Screwdriver

See chapter accessories
Order No. 9008370000



Ordering data

Solder pin length	3.2 mm
Colour	orange

Pitch 3.50 mm

Poles	L1 mm	(inch)	Qty.	Order No.	Order No.
4	3.50	(0.138)	100		1703700000
6	7.00	(0.276)	100		1703710000
8	10.50	(0.413)	100		1703720000
10	14.00	(0.551)	50		1703730000
12	17.50	(0.689)	50		1703740000
14	21.00	(0.827)	50		1703750000
16	24.50	(0.965)	50		1703760000
18	28.00	(1.102)	50		1703770000
20	31.50	(1.240)	50		1703780000
22	35.00	(1.378)	25		1703790000
24	38.50	(1.516)	25		1703800000
26	42.00	(1.654)	25		1703810000
28	45.50	(1.791)	25		1703820000
30	49.00	(1.929)	25		1703830000
32	52.50	(2.067)	25		1703840000
34	56.00	(2.205)	25		1703850000
36	59.50	(2.343)	25		1703860000
38	63.00	(2.480)	25		1703870000
40	66.50	(2.618)	25		1703880000
42	70.00	(2.756)	20		1703890000
44	73.50	(2.894)	20		1703900000
46	77.00	(3.031)	20		1703910000
48	80.50	(3.169)	20		1703920000

Clamping yoke connection for cross-sections up to 1.5 mm²

LS 5.08

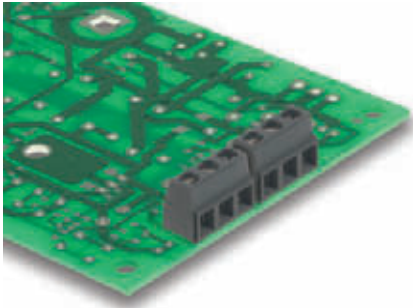

Small, compact and powerful - this PCB terminal with proven clamping yoke connection and 5.08 mm pitch has a capacity of 17.5 A. Conductor outlet direction 90°. Suitable for conductor cross-sections up to 1.5 mm².

- 0.20 - 1.5mm² (IEC) / 26 - 16 AWG (UL)
- 630 V (IEC) / 300 V (UL)
- 17.5 A (IEC) / 13.5 A (UL)

Derating curve

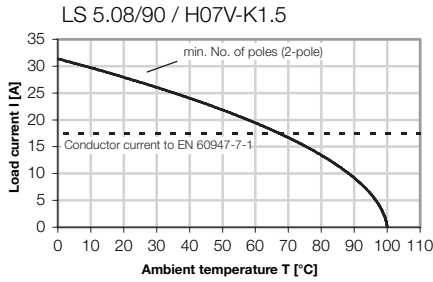

LS 5.08/90

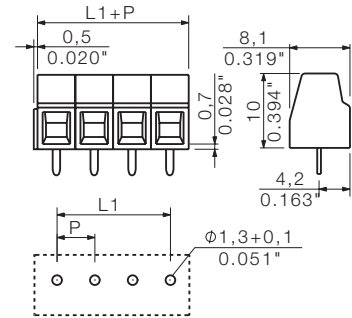

Technical data

Rated data to IEC 60664-1 / IEC 61984			
Clamping range, max.	mm ²	0.13...1.5	
Solid H05(07) V-U	mm ²	0.5...1.5	
Stranded H07 V-R	mm ²		
Flexible H05(07) V-K	mm ²	0.5...1.5	
Flexible with ferrule	mm ²	0.25...1.5	
Ferrule with plastic collar	mm ²	0.25...1.5	
Stripping length	mm	6	
Screwdriver blade	mm	0.6 x 3.5	
according to norm		DIN 5264	
Tightening torque range	Nm	0.4...0.5	
Rated current at ambient temperature			
	A	20°C	40°C
		17.5	17.5
Overvoltage category			
		III	III
Pollution severity			
		3	2
Rated voltage	V	250	320
Rated impulse voltage	kV	4	4
UL 1059 rated data - E60693			
		B	C
Rated voltage	V	300	300
Rated current	A	13.5	10
AWG conductor		26-16	
CSA C22.2 rated data - LR12400 B			
		B	C
Rated voltage	V	300	300
Rated current	A	13.5	10
AWG conductor		26-16	
Material data			
Type of insulating material		PA	
Flammability class acc. UL94		V-0	
Contact base material		Cu alloy	
Material of contact surface		tinned	

- Information**
- Rated current related to rated cross-section and min. No. of poles.
 - Wire end ferrule without plastic collar to DIN 46228 pt 1
 - Wire end ferrule with plastic collar to DIN 46228 pt 4
 - The data given under CSA relates to a cUL approval - E60693
 - P on drg. = pitch
 - Rated data refer only to the component itself. Clearance and creepage distances to other components are to be designed in accordance with the relevant application standards.

Ordering data

Solder pin length		3.5 mm	
Colour		black	
Pitch 5.08 mm			
Poles	L1 mm (inch)	Qty.	Order No.
2	5.08 (0.200)	100	1810850000
3	10.16 (0.400)	100	1810860000
4	15.24 (0.600)	100	1810870000
5	20.32 (0.800)	100	1810880000
6	25.40 (1.000)	100	1810890000
7	30.48 (1.200)	100	1810900000
8	35.56 (1.400)	100	1810910000
9	40.64 (1.600)	100	1810920000
10	45.72 (1.800)	100	1810930000
11	50.80 (2.000)	100	1810940000
12	55.88 (2.200)	100	1810950000

Accessories

Possible colors

Additional colours on request

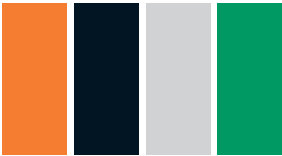

Marking strips

See chapter accessories



Screwdriver

See chapter accessories
Order No. 9008390000



Clamping yoke connection for cross-sections up to 2.5 mm²

LM 5.08
LM 5.00

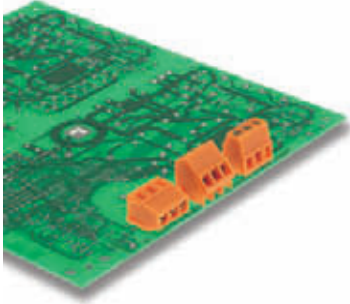

PCB terminal with proven clamping yoke connection in 5.00 and 5.08 mm pitch. Conductor outlet direction 90°, 135° and 180°. Suitable for conductor cross-sections up to 2.5 mm².

- 0.20 - 2.5 mm² (IEC) / 24 - 12 AWG (UL)
- 250 V (IEC) / 300 V (UL)
- 24 A (IEC) / 20 A (UL)

Derating curve

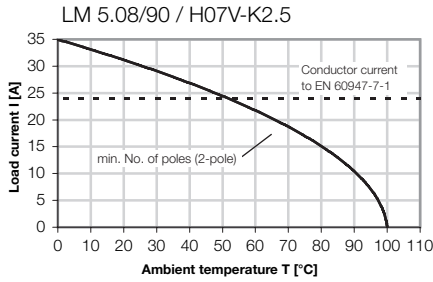

LM 5.08/90
LM 5.00/90

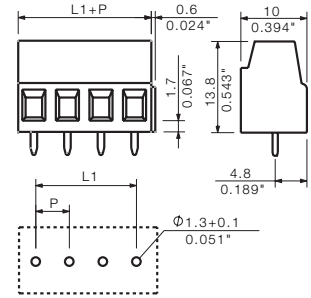

Technical data

Rated data to IEC 60664-1 / IEC 61984

Clamping range, max.	mm ²	0.2...3.31
Solid H05(07) V-U	mm ²	0.5...2.5
Stranded H07 V-R	mm ²	
Flexible H05(07) V-K	mm ²	0.5...2.5
Flexible with ferrule	mm ²	0.5...1.5
Ferrule with plastic collar	mm ²	0.5...1.5
Stripping length	mm	6
Screwdriver blade	mm	0.6 x 3.5
according to norm		DIN 5264
Tightening torque range	Nm	0.4...0.5

Rated current

at ambient temperature	20°C	40°C
A	24	24

Overtoltage category

	III	III	II
--	-----	-----	----

Pollution severity

	3	2	2
--	---	---	---

Rated voltage	V	250	250	250
Rated impulse voltage	kV	4	4	4

UL 1059 rated data - E60693

	B	C	D
--	---	---	---

Rated voltage	V	300	300
Rated current	A	20	10
AWG conductor		24-12	

CSA C22.2 rated data - LR12400 B

	B	C	D
--	---	---	---

Rated voltage	V	300	300
Rated current	A	20	10
AWG conductor		24-12	

Material data

Type of insulating material	PA
Flammability class acc. UL94	V-0
Contact base material	Cu alloy
Material of contact surface	tinned

Information

- Rated current related to rated cross-section and min. No. of poles.
- Wire end ferrule without plastic collar to DIN 46228 pt 1
- Wire end ferrule with plastic collar to DIN 46228 pt 4
- P on drg. = pitch
- Rated data refer only to the component itself. Clearance and creepage distances to other components are to be designed in accordance with the relevant application standards.

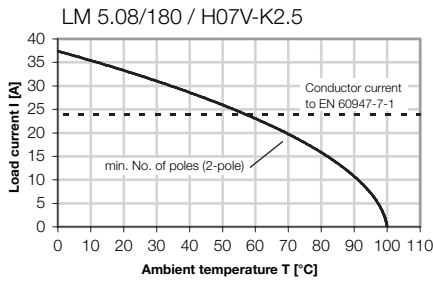
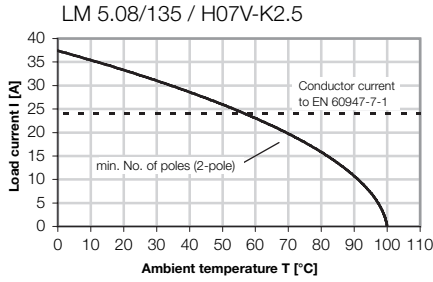

Ordering data

Solder pin length	3.5 mm
Colour	orange

Pitch 5.08 mm

Poles	L1 mm	(inch)	Qty.	Order No.	Order No.
2	5.08	(0.200)	500		1716080000
3	10.16	(0.400)	500		1716090000
4	15.24	(0.600)	50		9994130000
5	20.32	(0.800)	50		9994140000
6	25.40	(1.000)	50		9994150000
7	30.48	(1.200)	50		9994160000
8	35.56	(1.400)	50		9994170000
9	40.64	(1.600)	50		9994180000
10	45.72	(1.800)	50		9994190000
11	50.80	(2.000)	50		9994200000
12	55.88	(2.200)	50		9994210000

Pitch 5.00 mm

Poles	L1 mm	(inch)	Qty.	Order No.	Order No.
2	5.00	(0.197)	500		1715310000
3	10.00	(0.394)	500		1715320000
4	15.00	(0.591)	100		1821490000
5	20.00	(0.787)	50		1845310000
6	25.00	(0.984)	50		1845320000
7	30.00	(1.181)	50		1845330000
8	35.00	(1.378)	50		1845340000
9	40.00	(1.575)	50		1845350000
10	45.00	(1.772)	50		1845360000
11	50.00	(1.969)	50		1845370000
12	55.00	(2.165)	50		1845380000

LM 5.08/135
LM 5.00/135

LM 5.08/180
LM 5.00/180

Accessories

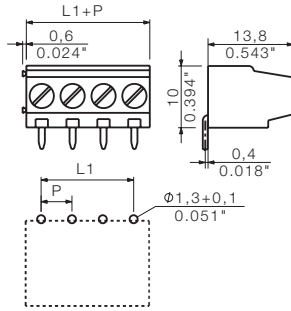
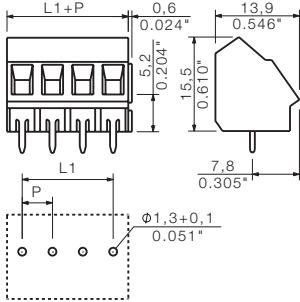

Possible colors

Additional colours on request



Marking strips

See chapter accessories

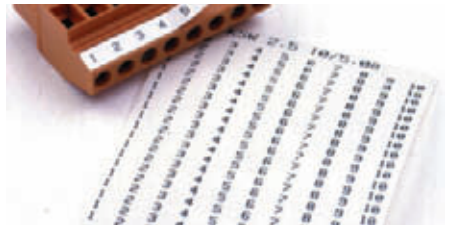

Screwdriver

See chapter accessories
Order No. 9008390000



Ordering data

Solder pin length	3.5 mm
Colour	orange

Pitch 5.08 mm

Poles	L1 mm	(inch)	Qty.	Order No.	Order No.
2	5.08	(0.200)	500		1716120000
3	10.16	(0.400)	500		1716130000
4	15.24	(0.600)	50		9994550000
5	20.32	(0.800)	50		9994560000
6	25.40	(1.000)	50		9994570000
7	30.48	(1.200)	50		9994580000
8	35.56	(1.400)	50		9994590000
9	40.64	(1.600)	50		9994600000
10	45.72	(1.800)	50		9994610000
11	50.80	(2.000)	50		9994620000
12	55.88	(2.200)	50		9994630000

Pitch 5.00 mm

Poles	L1 mm	(inch)	Qty.	Order No.	Order No.
2	5.00	(0.197)	500		1715350000
3	10.00	(0.394)	500		1715360000
4	15.00	(0.591)	50		1845390000
5	20.00	(0.787)	50		1845400000
6	25.00	(0.984)	50		1845410000
7	30.00	(1.181)	50		1845420000
8	35.00	(1.378)	50		1845430000
9	40.00	(1.575)	50		1845440000
10	45.00	(1.772)	50		1845450000
11	50.00	(1.969)	50		1845460000
12	55.00	(2.165)	50		1845470000

Ordering data

Solder pin length	3.5 mm
Colour	orange

Pitch 5.08 mm

Poles	L1 mm	(inch)	Qty.	Order No.	Order No.
2	5.08	(0.200)	500		1716100000
3	10.16	(0.400)	500		1716110000

Pitch 5.00 mm

Poles	L1 mm	(inch)	Qty.	Order No.	Order No.
2	5.00	(0.197)	500		1715330000
3	10.00	(0.394)	500		1715340000

Clamping yoke connection for cross-sections up to 2.5 mm²

LM 5.08 multi level

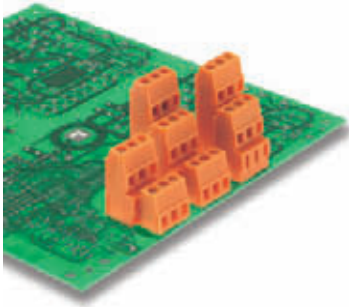

Modular multi level PCB terminal with proven clamping yoke connection at 5.08 mm pitch, conductor outlet direction 90°, suitable for conductor cross-sections up to 2.5 mm².

- 0.20 - 2.5 mm² (IEC) / 24 - 12 AWG (UL)
- 250 V (IEC) / 300 V (UL)
- 24 A (IEC) / 20 A (UL)

Derating curve

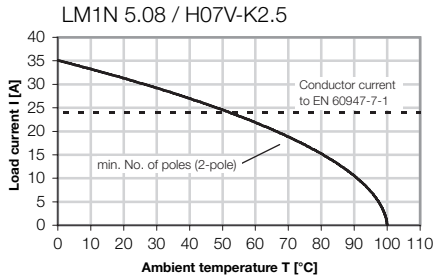

LM1N 5.08

single row middle

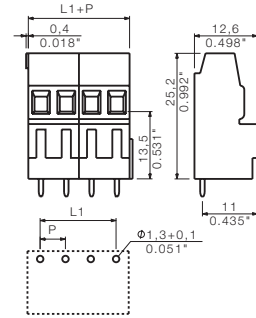

Technical data

Rated data to IEC 60664-1 / IEC 61984

Clamping range, max.	mm ²	0.2...3.31
Solid H05(07) V-U	mm ²	0.5...2.5
Stranded H07 V-R	mm ²	
Flexible H05(07) V-K	mm ²	0.5...2.5
Flexible with ferrule	mm ²	0.5...1.5
Ferrule with plastic collar	mm ²	0.5...1.5
Stripping length	mm	6
Screwdriver blade	mm	0.6 x 3.5
according to norm		DIN 5264
Tightening torque range	Nm	0.4...0.5

Rated current

at ambient temperature		20°C	40°C
LM1N 5.08	A	24	24
LM1H 5.08	A	24	24

Overvoltage category

	III	III	II
Pollution severity	3	2	2
Rated voltage	V	250	250
Rated impulse voltage	kV	4	4

UL 1059 rated data - E60693

	B	C	D
Rated voltage	V	300	300
Rated current	A	20	10
AWG conductor		24-12	

CSA C22.2 rated data - LR12400 B

	B	C	D
Rated voltage	V	300	300
Rated current	A	20	10
AWG conductor		24-12	

Material data

Type of insulating material	PA
Flammability class acc. UL94	V-0
Contact base material	Cu alloy
Material of contact surface	tinned

Information

- Rated current related to rated cross-section and min. No. of poles.
- Wire end ferrule without plastic collar to DIN 46228 pt 1
- Wire end ferrule with plastic collar to DIN 46228 pt 4
- P on drg. = pitch
- Rated data refer only to the component itself. Clearance and creepage distances to other components are to be designed in accordance with the relevant application standards.

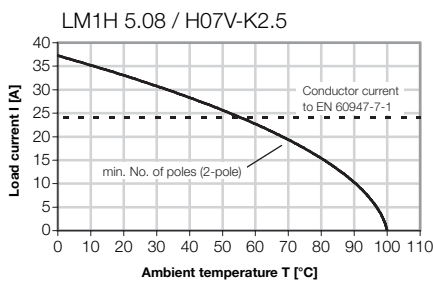

Ordering data

Solder pin length	3.5 mm
Colour	orange

Pitch 5.08 mm

Poles	L1 mm	(inch)	Qty.	Order No.	Order No.
2	5.08	(0.200)	500		1766300000
3	10.16	(0.400)	500		1766310000

LM1H 5.08

1 row or high level

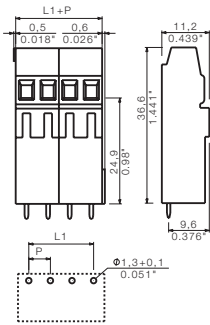

Accessories

Possible colors

Additional colours on request



Marking strips

See chapter accessories



Ordering data

Solder pin length	3.5 mm
Colour	orange

Pitch 5.08 mm

Poles	L1 mm	(inch)	Qty.	Order No.	Order No.
2	5.08	(0.200)	250		1766360000
3	10.16	(0.400)	250		1766370000

Screwdriver

See chapter accessories
Order No. 9008390000



Clamping yoke connection for cross-sections up to 2.5 mm²

LM 5.08 multi level

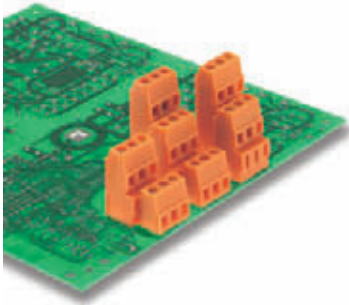

Multi level PCB terminal with proven clamping yoke connection in 5.08 mm pitch. Conductor outlet direction 90°. Suitable for conductor cross-sections up to 2.5 mm².

- 0.20 - 2.5 mm² (IEC) / 24 - 12 AWG (UL)
- 250 V (IEC) / 300 V (UL)
- 24 A (IEC) / 20 A (UL)

Derating curve

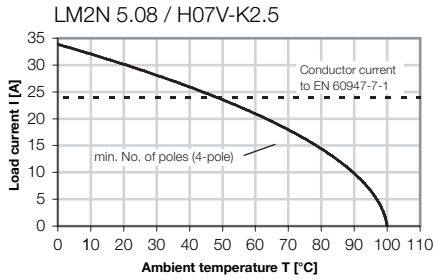

LM2N 5.08

Double level row

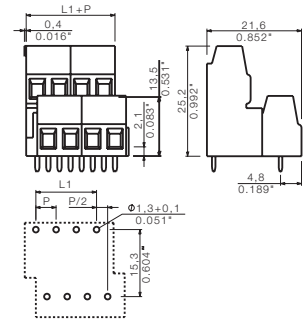

Technical data

Rated data to IEC 60664-1 / IEC 61984

Clamping range, max.	mm ²	0.2...3.31	
Solid H05(07) V-U	mm ²	0.5...2.5	
Stranded H07 V-R	mm ²		
Flexible H05(07) V-K	mm ²	0.5...2.5	
Flexible with ferrule	mm ²	0.5...1.5	
Ferrule with plastic collar	mm ²	0.5...1.5	
Stripping length	mm	6	
Screwdriver blade	mm	0.6 x 3.5	
according to norm		DIN 5264	
Tightening torque range	Nm	0.4...0.5	

Rated current

at ambient temperature		20°C	40°C
LM2N 5.08	A	24	24
LM2H 5.08	A	24	24
LM3R 5.08	A	24	24

Overvoltage category

Pollution severity

	III	III	II
Rated voltage	V	250	250
Rated impulse voltage	kV	4	4

UL 1059 rated data - E60693

	B	C	D
Rated voltage	V	300	300
Rated current	A	20	10
AWG conductor		24-12	

CSA C22.2 rated data - LR12400 B

	B	C	D
Rated voltage	V	300	300
Rated current	A	20	10
AWG conductor		24-12	

Material data

Type of insulating material	PA
Flammability class acc. UL94	V-0
Contact base material	Cu alloy
Material of contact surface	tinned

Information

- Rated current related to rated cross-section and min. No. of poles.
- Wire end ferrule without plastic collar to DIN 46228 pt 1
- Wire end ferrule with plastic collar to DIN 46228 pt 4
- P on drg. = pitch
- Rated data refer only to the component itself. Clearance and creepage distances to other components are to be designed in accordance with the relevant application standards.

LM2H 5.08 / H07V-K2.5

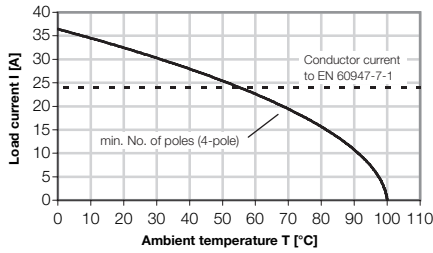

LM3R 5.08 / H07V-K2.5

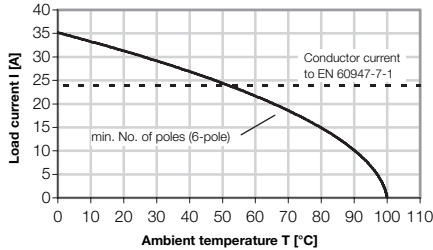

Ordering data

Solder pin length		3.5 mm	
Colour		orange	
Pitch 5.08 mm			
Poles	L1 mm (inch)	Qty.	Order No.
4	5.08 (0.200)	50	1768850000
6	10.16 (0.400)	50	1768860000
8	15.24 (0.600)	50	1768870000
10	20.32 (0.800)	50	1768880000
12	25.40 (1.000)	20	1768890000
14	30.48 (1.200)	20	1768900000
16	35.56 (1.400)	20	1768910000
18	40.64 (1.600)	20	1768920000
20	45.72 (1.800)	20	1768930000
22	50.80 (2.000)	20	1768940000
24	55.88 (2.200)	10	1768950000
26	60.96 (2.400)	10	1768960000
28	66.04 (2.600)	10	1768970000
30	71.12 (2.800)	10	1768980000
32	76.20 (3.000)	10	1768990000
34	81.28 (3.200)	10	1769000000
36	86.36 (3.400)	10	1769010000
38	91.44 (3.600)	10	1769020000
40	96.52 (3.800)	10	1769030000
42	101.60 (4.000)	10	1769040000
44	106.68 (4.200)	10	1769050000
46	111.76 (4.400)	10	1769060000
48	116.84 (4.600)	10	1769070000

LM2H 5.08

Double level row high

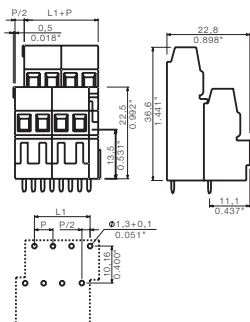

Ordering data

Solder pin length		3.5 mm	
Colour		orange	
Pitch 5.08 mm			
Poles	L1 mm (inch)	Qty.	Order No.
4	5.08 (0.200)	50	1769240000
6	10.16 (0.400)	50	1769250000
8	15.24 (0.600)	50	1769260000
10	20.32 (0.800)	50	1769270000
12	25.40 (1.000)	20	1769280000
14	30.48 (1.200)	20	1769290000
16	35.56 (1.400)	20	1769300000
18	40.64 (1.600)	20	1769310000
20	45.72 (1.800)	20	1769320000
22	50.80 (2.000)	20	1769330000
24	55.88 (2.200)	10	1769340000
26	60.96 (2.400)	10	1769350000
28	66.04 (2.600)	10	1769360000
30	71.12 (2.800)	10	1769370000
32	76.20 (3.000)	10	1769380000
34	81.28 (3.200)	10	1769390000
36	86.36 (3.400)	10	1769400000
38	91.44 (3.600)	10	1769410000
40	96.52 (3.800)	10	1769420000
42	101.60 (4.000)	10	1769430000
44	106.68 (4.200)	10	1769440000
46	111.76 (4.400)	10	1769450000
48	111.76 (4.400)	10	1769460000

LM3R 5.08

Triple level

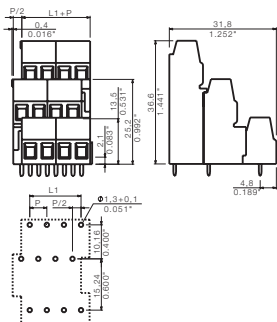

Ordering data

Solder pin length		3.5 mm	
Colour		orange	
Pitch 5.08 mm			
Poles	L1 mm (inch)	Qty.	Order No.
6	5.08 (0.200)	50	1769620000
9	10.16 (0.400)	50	1769630000
12	15.24 (0.600)	50	1769640000
15	20.32 (0.800)	25	1769650000
18	25.40 (1.000)	25	1769660000
21	30.48 (1.200)	20	1769670000
24	35.56 (1.400)	20	1769680000
27	40.64 (1.600)	20	1769690000
30	45.72 (1.800)	10	1769700000
33	50.80 (2.000)	10	1769710000
36	55.88 (2.200)	10	1769720000
39	60.96 (2.400)	10	1769730000
42	66.04 (2.600)	10	1769740000
45	71.12 (2.800)	10	1769750000
48	76.20 (3.000)	10	1769760000
51	81.28 (3.200)	10	1769770000
54	86.36 (3.400)	5	1769780000
57	91.44 (3.600)	5	1769790000
60	96.52 (3.800)	5	1769800000
63	101.60 (4.000)	5	1769810000
66	106.68 (4.200)	5	1769820000
69	111.76 (4.400)	5	1769830000
72	116.84 (4.600)	5	1769840000

Accessories

Possible colors

Additional colours on request



Marking strips

See chapter accessories

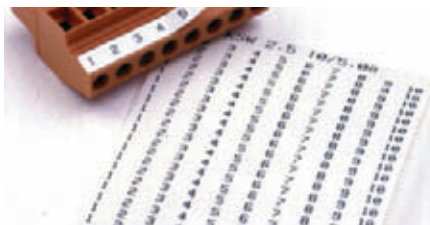

Screwdriver

See chapter accessories
Order No. 9008390000



Clamping yoke connection for cross-sections up to 6 mm²

LP 5.08
LP 5.00

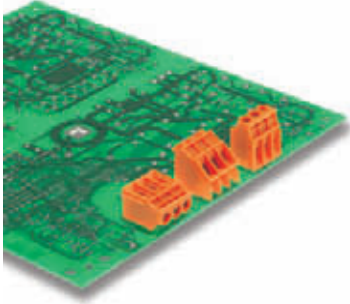

This PCB terminal provides connections for 32 A and 6 mm² conductor cross-section with established clamping yoke connection at 5.00 and 5.08 mm pitch, conductor outlet direction in 90° and 180° design, with extensive auxiliary functions

- 0.20 - 6.0mm² (IEC) / 26 - 12 AWG (UL)
- 500 V (IEC) / 300 V (UL)
- 32 A (IEC) / 20 A (UL)

Derating curve

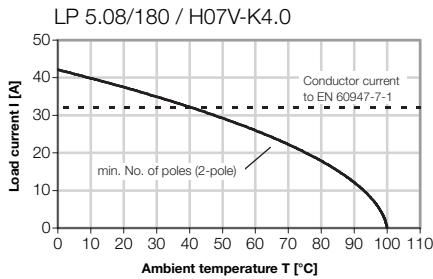
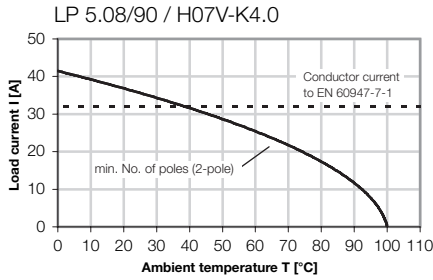

LP 5.08/90
LP 5.00/90

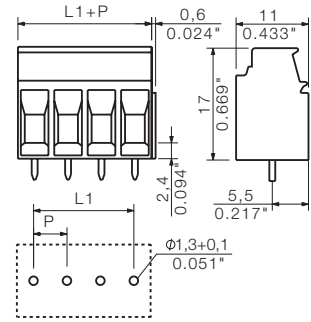

Technical data

Rated data to IEC 60664-1 / IEC 61984			
Clamping range, max.	mm ²	0.13...6	
Solid H05(07) V-U	mm ²	0.5...6	
Stranded H07 V-R	mm ²		
Flexible H05(07) V-K	mm ²	0.5...4	
Flexible with ferrule	mm ²	0.5...2.5	
Ferrule with plastic collar	mm ²	0.5...2.5	
Stripping length	mm	6	
Screwdriver blade	mm	0.6 x 3.5	
according to norm		DIN 5264	
Tightening torque range	Nm	0.5...0.6	
Rated current at ambient temperature			
	A	20°C	40°C
		32	32
Overvoltage category			
		III	III
Pollution severity			
		3	2
		2	2
Rated voltage	V	250	250
Rated impulse voltage	kV	4	4
		4	4
UL 1059 rated data - E60693			
		B	C
		D	
Rated voltage	V	300	300
Rated current	A	20	10
AWG conductor		26-12	
CSA C22.2 rated data - LR12400 B			
		B	C
		D	
Rated voltage	V	300	300
Rated current	A	20	10
AWG conductor		26-12	
Material data			
Type of insulating material		PA	
Flammability class acc. UL94		V-2	
Contact base material		Cu alloy	
Material of contact surface		tinned	
Information			

- Additional colours on request
- Rated current related to rated cross-section and min. No. of poles.
- Wire end ferrule without plastic collar to DIN 46228 pt 1
- Wire end ferrule with plastic collar to DIN 46228 pt 4
- P on drg. = pitch
- Rated data refer only to the component itself. Clearance and creepage distances to other components are to be designed in accordance with the relevant application standards.

Ordering data

Solder pin length	3.2 mm				
Colour	orange				
Pitch 5.08 mm					
Poles	L1 mm	(inch)	Qty.	Order No.	Order No.
2	5.08	(0.200)	100		1592820000
3	10.16	(0.400)	100		1592830000
4	15.24	(0.600)	100		1594360000
5	20.32	(0.800)	50		1724530000
6	25.40	(1.000)	50		1608250000
7	30.48	(1.200)	50		1759120000
8	35.56	(1.400)	50		1594370000
9	40.64	(1.600)	50		1759130000
10	45.72	(1.800)	50		1594380000
11	50.80	(2.000)	50		1760480000
12	55.88	(2.200)	50		1608270000
13	60.96	(2.400)	50		1759140000
14	66.04	(2.600)	50		1759150000
15	71.12	(2.800)	50		1759160000
16	76.20	(3.000)	50		1594390000
17	81.28	(3.200)	20		1759170000
18	86.36	(3.400)	20		1759180000
19	91.44	(3.600)	20		1844450000
20	96.52	(3.800)	20		1759190000
21	101.60	(4.000)	20		1759200000
22	106.68	(4.200)	20		1844460000
23	111.76	(4.400)	20		1844470000
24	116.84	(4.600)	20		1608290000
Pitch 5.00 mm					
Poles	L1 mm	(inch)	Qty.	Order No.	Order No.
2	5.00	(0.197)	100		1594320000
3	10.00	(0.394)	100		1594330000
4	15.00	(0.591)	100		1608310000
5	20.00	(0.787)	50		1759100000
6	25.00	(0.984)	50		1608330000
7	30.00	(1.181)	50		1844480000
8	35.00	(1.378)	50		1608350000
9	40.00	(1.575)	50		1753300000
10	45.00	(1.772)	50		1608370000
11	50.00	(1.969)	50		1844490000
12	55.00	(2.165)	50		1608390000
16	75.00	(2.953)	50		1608410000
24	115.00	(4.528)	20		1608430000

LP 5.08/180
LP 5.00/180

Accessories

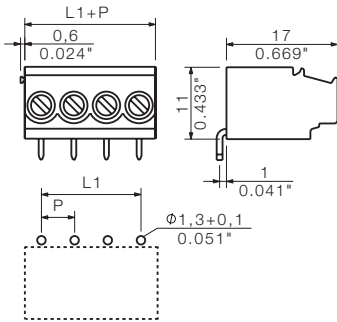

Possible colors

Additional colours on request



Spacer + fixing block

See chapter accessories



Marking and function indicator

See chapter accessories



Fuse element and disconnection element

See chapter accessories



Screwdriver

See chapter accessories
Order No. 9008390000



Ordering data

Solder pin length	3.2 mm
Colour	orange

Pitch 5.08 mm

Poles	L1 mm	(inch)	Qty.	Order No.	Order No.
2	5.08	(0.200)	100		1753810000
3	10.16	(0.400)	100		1753820000

Pitch 5.00 mm

Poles	L1 mm	(inch)	Qty.	Order No.	Order No.
2	5.00	(0.197)	100		1761330000
3	10.00	(0.394)	100		1761340000

Clamping yoke connection for cross-sections up to 6 mm²

LP 5.08
LP 5.00

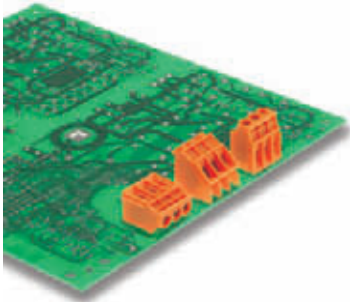

Test point, 32 A and 6 mm² conductor cross-section are feasible with this PCB terminal with proven clamping yoke connection at 5.00 and 5.08 mm pitch, conductor outlet direction 90° and 135°, with extensive auxiliary functions.

- 0.20 - 6.0mm² (IEC) / 26 - 12 AWG (UL)
- 500 V (IEC) / 300 V (UL)
- 32 A (IEC) / 20 A (UL)

Derating curve

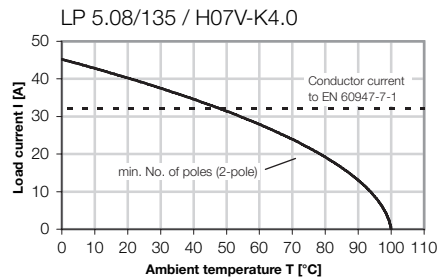
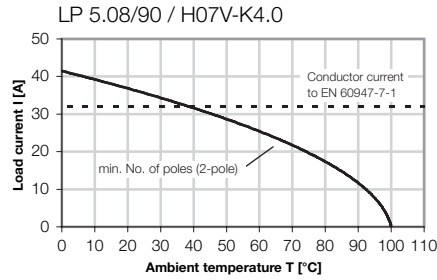

LPP 5.08/90
LPP 5.00/90

with test point

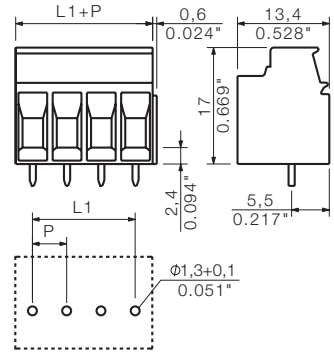

Technical data

Rated data to IEC 60664-1 / IEC 61984

Clamping range, max.	mm ²	0.13...6
Solid H05(07) V-U	mm ²	0.5...6
Stranded H07 V-R	mm ²	
Flexible H05(07) V-K	mm ²	0.5...4
Flexible with ferrule	mm ²	0.5...2.5
Ferrule with plastic collar	mm ²	0.5...2.5
Stripping length	mm	6
Screwdriver blade	mm	0.6 x 3.5
according to norm		DIN 5264
Tightening torque range	Nm	0.5...0.6

Rated current

at ambient temperature	20°C	40°C
A	32	32

Overvoltage category

III	III	II
-----	-----	----

Pollution severity

3	2	2
---	---	---

Rated voltage	V	250	250	500
Rated impulse voltage	kV	4	4	4

UL 1059 rated data - E60693

		B	C	D
--	--	----------	----------	----------

Rated voltage	V	300	300
Rated current	A	20	10
AWG conductor		26-12	

CSA C22.2 rated data - LR12400 B

		B	C	D
--	--	----------	----------	----------

Rated voltage	V	300	300
Rated current	A	20	10
AWG conductor		26-12	

Material data

Type of insulating material	PA
Flammability class acc. UL94	V-2
Contact base material	Cu alloy
Material of contact surface	tinned

Information

- Additional colours on request
- Rated current related to rated cross-section and min. No. of poles.
- Wire end ferrule without plastic collar to DIN 46228 pt 1
- Wire end ferrule with plastic collar to DIN 46228 pt 4
- P on drg. = pitch
- Rated data refer only to the component itself. Clearance and creepage distances to other components are to be designed in accordance with the relevant application standards.

Ordering data

Solder pin length	3.2 mm
-------------------	--------

Colour	orange
--------	--------

Pitch 5.08 mm

Poles	L1 mm	(inch)	Qty.	Order No.	Order No.
2	5.08	(0.200)	100		1594400000
3	10.16	(0.400)	100		1594410000

Pitch 5.00 mm

Poles	L1 mm	(inch)	Qty.	Order No.	Order No.
2	5.00	(0.197)	100		1594340000
3	10.00	(0.394)	100		1594350000

LP 5.08/135
LP 5.00/135

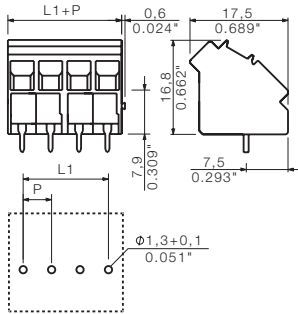

Accessories

Possible colors

Additional colours on request



Spacer + fixing block

See chapter accessories



Marking and function indicator

See chapter accessories



Fuse element and disconnection element

See chapter accessories



Test plug

See chapter accessories



Ordering data

Solder pin length 3.2 mm

Colour orange

Pitch 5.08 mm

Poles	L1 mm	(inch)	Qty.	Order No.	Order No.
2	5.08	(0.200)	100		1595730000
3	10.16	(0.400)	100		1595690000
4	15.24	(0.600)	100		1759210000
5	20.32	(0.800)	50		1843150000
6	25.40	(1.000)	50		1759360000
7	30.48	(1.200)	50		1843160000
8	35.56	(1.400)	50		1752940000
9	40.64	(1.600)	50		1843170000
10	45.72	(1.800)	50		1843180000
11	50.80	(2.000)	50		1843190000
12	55.88	(2.200)	50		1843200000

Pitch 5.00 mm

Poles	L1 mm	(inch)	Qty.	Order No.	Order No.
2	5.00	(0.197)	100		1595750000
3	10.00	(0.394)	100		1595710000
4	15.00	(0.591)	50		1791710000
5	20.00	(0.787)	50		1843210000
6	25.00	(0.984)	50		1843220000
7	30.00	(1.181)	50		1843230000
8	35.00	(1.378)	50		1843240000
9	40.00	(1.575)	50		1843250000
10	45.00	(1.772)	50		1843260000
11	50.00	(1.969)	50		1843270000
12	55.00	(2.165)	50		1843280000

Clamping yoke connection for cross-sections up to 6 mm²

LP 5.08 multi level
LP 5.00 multi level

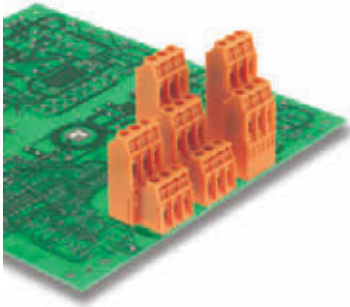

Modular multi level PCB terminal with proven clamping yoke connection at 5.08 mm pitch, conductor outlet direction 90°, suitable for conductor cross-sections up to 6.0 mm².

- 0.20 - 6.0mm² (IEC) / 26 - 12 AWG (UL)
- 500 V (IEC) / 300 V (UL)
- 32 A (IEC) / 20 A (UL)

Derating curve

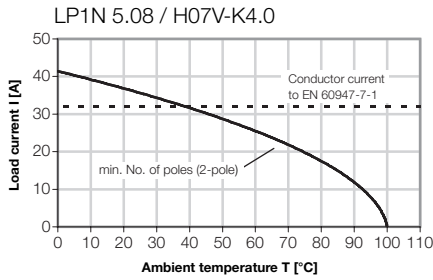

LP1N 5.08
LP1N 5.00

single row middle

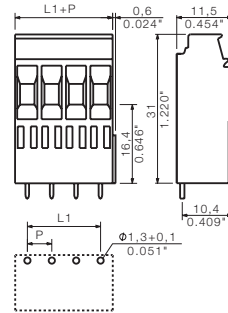

Technical data

Rated data to IEC 60664-1 / IEC 61984

Clamping range, max.	mm ²	0.13...6
Solid H05(07) V-U	mm ²	0.5...6
Stranded H07 V-R	mm ²	
Flexible H05(07) V-K	mm ²	0.5...4
Flexible with ferrule	mm ²	0.5...2,5
Ferrule with plastic collar	mm ²	0.5...2,5
Stripping length	mm	6
Screwdriver blade	mm	0.6 x 3.5
according to norm		DIN 5264
Tightening torque range	Nm	0.5...0.6

Rated current

at ambient temperature		20°C	40°C
LP1N 5.08	A	32	32
LP1H 5.08	A	32	32

Overvoltage category

	III	III	II
--	-----	-----	----

Pollution severity

	3	2	2
--	---	---	---

Rated voltage V

Rated impulse voltage kV

UL 1059 rated data - E60693

	B	C	D
--	---	---	---

Rated voltage V

Rated current A

AWG conductor 26-12

CSA C22.2 rated data - LR12400 B

	B	C	D
--	---	---	---

Rated voltage V

Rated current A

AWG conductor 26-12

Material data

Type of insulating material PA

Flammability class acc. UL94 V-2

Contact base material Cu alloy

Material of contact surface tinned

Information

- Additional colours on request
- Rated current related to rated cross-section and min. No. of poles.
- Wire end ferrule without plastic collar to DIN 46228 pt 1
- Wire end ferrule with plastic collar to DIN 46228 pt 4
- P on drg. = pitch
- Rated data refer only to the component itself. Clearance and creepage distances to other components are to be designed in accordance with the relevant application standards.

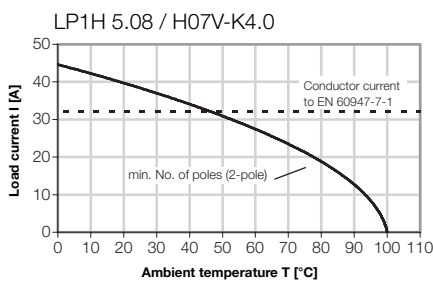

Ordering data

Solder pin length 3.2 mm

Colour orange

Pitch 5.08 mm

Poles	L1 mm	(inch)	Qty.	Order No.	Order No.
2	5.08	(0.200)	100		1640830000
3	10.16	(0.400)	100		1640840000

Pitch 5.00 mm

Poles	L1 mm	(inch)	Qty.	Order No.	Order No.
2	5.00	(0.197)	100		1640870000
3	10.00	(0.394)	100		1640880000

LP1H 5.08

1 row or high level

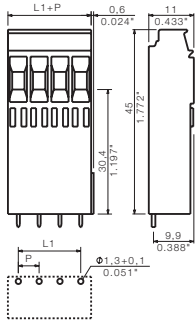

Accessories

Possible colors

Additional colours on request



Marking system

See chapter accessories



Marking and function indicator

See chapter accessories



Screwdriver

See chapter accessories
Order No. 9008390000



Ordering data

Solder pin length 3.2 mm

Colour orange

Pitch 5.08 mm

Poles	L1 mm	(inch)	Qty.	Order No.	Order No.
2	5.08	(0.200)	100		1640910000
3	10.16	(0.400)	100		1640920000

Clamping yoke connection for cross-sections up to 6 mm²

LP 5.08 multi level
LP 5.00 multi level

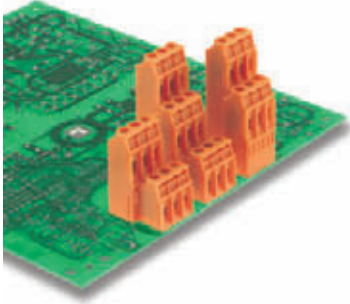

Multi level PCB terminal with proven clamping yoke connection in 5.08 mm pitch. Conductor outlet direction 90°. Suitable for conductor cross-sections up to 2.5 mm².

- 0.20 - 6.0mm² (IEC) / 26 - 12 AWG (UL)
- 500 V (IEC) / 300 V (UL)
- 32 A (IEC) / 20 A (UL)

Technical data

Rated data to IEC 60664-1 / IEC 61984

Clamping range, max.	mm ²	0.13...6	
Solid H05(07) V-U	mm ²	0.5...6	
Stranded H07 V-R	mm ²		
Flexible H05(07) V-K	mm ²	0.5...4	
Flexible with ferrule	mm ²	0.5...2.5	
Ferrule with plastic collar	mm ²	0.5...2.5	
Stripping length	mm	6	
Screwdriver blade	mm	0.6 x 3.5	
according to norm		DIN 5264	
Tightening torque range	Nm	0.5...0.6	

Rated current

at ambient temperature		20°C	40°C
LP2N 5.08	A	32	32
LP2HR 5.08	A	32	32
LP3R 5.08	A	32	30

Overvoltage category

Pollution severity	III	III	II	
Rated voltage	V	250	250	500
Rated impulse voltage	kV	4	4	4

UL 1059 rated data - E60693

	B	C	D
Rated voltage	V	300	300
Rated current	A	20	10
AWG conductor		26-12	

CSA C22.2 rated data - LR12400 B

	B	C	D
Rated voltage	V	300	300
Rated current	A	20	10
AWG conductor		26-12	

Material data

Type of insulating material	PA
Flammability class acc. UL94	V-2
Contact base material	Cu alloy
Material of contact surface	tinned

Information

- Additional colours on request
- Rated current related to rated cross-section and min. No. of poles.
- Wire end ferrule without plastic collar to DIN 46228 pt 1
- Wire end ferrule with plastic collar to DIN 46228 pt 4
- P on drg. = pitch
- Rated data refer only to the component itself. Clearance and creepage distances to other components are to be designed in accordance with the relevant application standards.

Derating curve

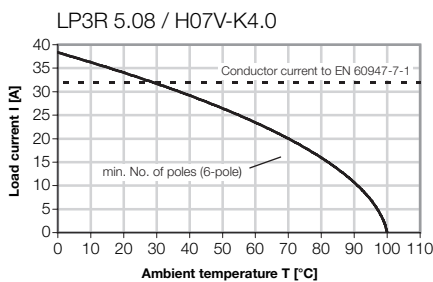
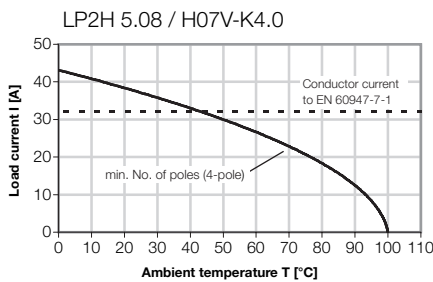
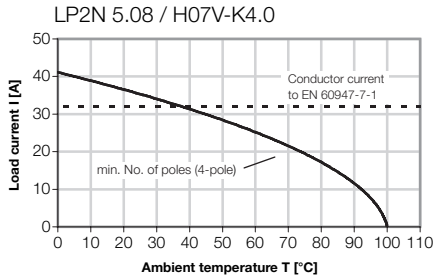

LP2N 5.08
LP2N 5.00

Double level row

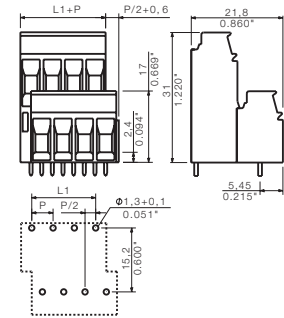

Ordering data

Solder pin length	3.2 mm
Colour	orange

Pitch 5.08 mm

Poles	L1 mm	(inch)	Qty.	Order No.	Order No.
4	5.08	(0.200)	50		1635140000
6	10.16	(0.400)	50		1625540000
8	15.24	(0.600)	50		1596460000
10	20.32	(0.800)	50		1596510000
12	25.40	(1.000)	50		1844510000
14	30.48	(1.200)	50		1844520000
16	35.56	(1.400)	20		1596530000
18	40.64	(1.600)	20		1844530000
20	45.72	(1.800)	20		1596570000
22	50.80	(2.000)	20		1844540000
24	55.88	(2.200)	10		1596610000
26	60.96	(2.400)	10		1844550000
28	66.04	(2.600)	10		1844660000
30	71.12	(2.800)	10		1596650000
32	76.20	(3.000)	10		1844570000
34	81.28	(3.200)	10		1844580000
36	86.36	(3.400)	10		1844590000
38	91.44	(3.600)	10		1844600000
40	96.52	(3.800)	10		1844610000
42	101.60	(4.000)	10		1844620000
44	106.68	(4.200)	10		1844630000
46	111.76	(4.400)	10		1844640000
48	116.84	(4.600)	10		1844650000

Pitch 5.00 mm

Poles	L1 mm	(inch)	Qty.	Order No.	Order No.
4	5.00	(0.197)	50		1635160000
6	10.00	(0.394)	50		1625560000
8	15.00	(0.591)	50		1596450000
10	20.00	(0.787)	50		1596490000
16	35.00	(1.378)	20		1596550000
20	45.00	(1.772)	20		1596590000
24	55.00	(2.165)	10		1596630000
30	70.00	(2.756)	10		1596670000

LP2HR 5.08

Double level row high

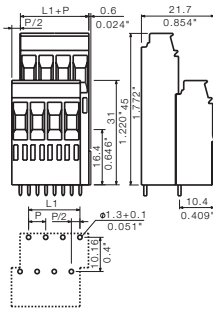

Ordering data

Solder pin length	3.2 mm
Colour	orange

Pitch 5.08 mm

Poles	L1 mm	(inch)	Qty.	Order No.	Order No.
4	5.08	(0.200)	50		1636210000
6	10.16	(0.400)	50		1636220000
8	15.24	(0.600)	50		1636230000
10	20.32	(0.800)	50		1636240000
12	25.40	(1.000)	20		1844660000
14	30.48	(1.200)	20		1844670000
16	35.56	(1.400)	20		1636250000
18	40.64	(1.600)	20		1844680000
20	45.72	(1.800)	20		1636260000
22	50.80	(2.000)	20		1613260000
24	55.88	(2.200)	10		1636270000
26	60.96	(2.400)	10		1844690000
28	66.04	(2.600)	10		1844700000
30	71.12	(2.800)	10		1636280000
32	76.20	(3.000)	10		1844710000
34	81.28	(3.200)	10		1844720000
36	86.36	(3.400)	10		1844730000
38	91.44	(3.600)	10		1844740000
40	96.52	(3.800)	10		1844750000
42	101.60	(4.000)	10		1844760000
44	106.68	(4.200)	10		1844770000
46	111.76	(4.400)	10		1844780000
48	116.84	(4.600)	10		1646480000

LP3R 5.08

Triple level

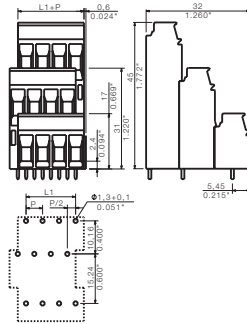

Ordering data

Solder pin length	3.2 mm
Colour	orange

Pitch 5.08 mm

Poles	L1 mm	(inch)	Qty.	Order No.	Order No.
6	5.08	(0.200)	50		1653930000
9	10.16	(0.400)	50		1596320000
12	15.24	(0.600)	50		1596340000
15	20.32	(0.800)	25		1596360000
18	25.40	(1.000)	25		1596380000
21	30.48	(1.200)	20		1844790000
24	35.56	(1.400)	20		1596400000
27	40.64	(1.600)	10		1844800000
30	45.72	(1.800)	10		1596420000
33	50.80	(2.000)	10		1844810000
36	55.88	(2.200)	10		1844820000
39	60.96	(2.400)	10		1844830000
42	66.04	(2.600)	10		1844840000
45	71.12	(2.800)	10		1844850000
48	76.20	(3.000)	10		1844860000
51	81.28	(3.200)	10		1844870000
54	86.36	(3.400)	10		1844880000
57	91.44	(3.600)	5		1844890000
60	96.52	(3.800)	5		1844900000
63	101.60	(4.000)	5		1844910000
66	106.68	(4.200)	5		1844920000
69	111.76	(4.400)	5		1844930000
72	116.84	(4.600)	5		1844940000

Accessories

Possible colors

Additional colours on request



Marking system

See chapter accessories



Marking and function indicator

See chapter accessories



Screwdriver

See chapter accessories
Order No. 9008390000



Accessories

Possible colors

Additional colours on request



Marking system

See chapter accessories



Test plug

See chapter accessories



Screwdriver

See chapter accessories
Order No. 9008390000



Clamping yoke connection for cross-sections up to 6 mm²

LPP 7.62
LPP 7.50

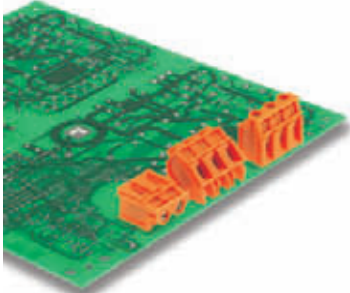

This PCB terminal provides connections for 1000 V, 32 A and 6 mm² conductor cross-section with established clamping yoke connection at 7.50 and 7.62 mm pitch, conductor outlet direction in 90° and 180° design

- 0.20 - 6.0mm² (IEC) / 26 - 12 AWG (UL)
- 1000 V (IEC) / 300 V (UL)
- 32 A (IEC) / 20 A (UL)

Derating curve

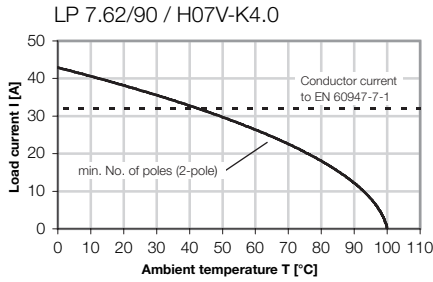

LP 7.62/90
LP 7.50/90

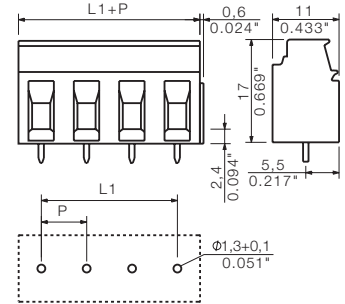

Technical data

Rated data to IEC 60664-1 / IEC 61984			
Clamping range, max.	mm ²	0.13...6	
Solid H05(07) V-U	mm ²	0.5...6	
Stranded H07 V-R	mm ²	...6	
Flexible H05(07) V-K	mm ²	0.5...4	
Flexible with ferrule	mm ²	0.5...2.5	
Ferrule with plastic collar	mm ²	0.5...2.5	
Stripping length	mm	6	
Screwdriver blade	mm	0.6 x 3.5	
according to norm		DIN 5264	
Tightening torque range	Nm	0.5...0.6	
Rated current at ambient temperature			
	A	20°C	40°C
		32	32
Overvoltage category			
		III	III
Pollution severity			
		3	2
		2	2
Rated voltage	V	500	500
Rated impulse voltage	kV	6	6
UL 1059 rated data - E60693			
		B	C
Rated voltage	V	300	300
Rated current	A	20	10
AWG conductor		26-12	
CSA C22.2 rated data - LR12400 B			
		B	C
Rated voltage	V	300	300
Rated current	A	20	10
AWG conductor		26-12	
Material data			
Type of insulating material		PA	
Flammability class acc. UL94		V-2	
Contact base material		Cu alloy	
Material of contact surface		tinned	
Information			

- Additional colours on request
- Rated current related to rated cross-section and min. No. of poles.
- Wire end ferrule without plastic collar to DIN 46228 pt 1
- Wire end ferrule with plastic collar to DIN 46228 pt 4
- P on drg. = pitch
- Rated data refer only to the component itself. Clearance and creepage distances to other components are to be designed in accordance with the relevant application standards.

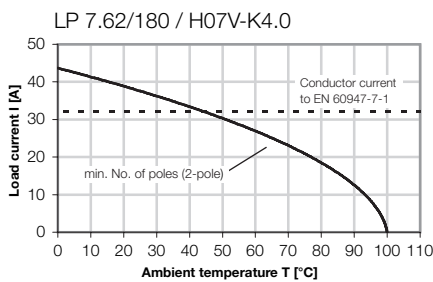

Ordering data

Solder pin length	3.2 mm		
Colour	orange		
Pitch 7.62 mm			
Poles	L1 mm	(inch)	Qty.
2	7.62	(0.300)	100
3	15.24	(0.600)	100
			Order No.
			Order No.
			1594460000
			1594470000
Pitch 7.50 mm			
Poles	L1 mm	(inch)	Qty.
2	7.50	(0.295)	100
3	15.00	(0.591)	100
			Order No.
			Order No.
			1594420000
			1594430000

LP 7.62/180
LP 7.50/180

Accessories

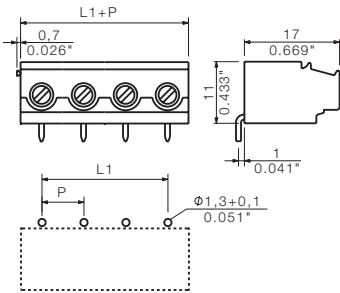

Possible colors

Additional colours on request



Marking system

See chapter accessories



Ordering data

Solder pin length	3.2 mm
Colour	orange

Pitch 7.62 mm

Poles	L1 mm	(inch)	Qty.	Order No.	Order No.
2	7.62	(0.300)	100		1753890000
3	15.24	(0.600)	100		1753900000

Pitch 7.50 mm

Poles	L1 mm	(inch)	Qty.	Order No.	Order No.
2	7.50	(0.295)	100		1761370000
3	15.00	(0.591)	100		1761380000

Screwdriver

See chapter accessories
Order No. 9008390000



Clamping yoke connection for cross-sections up to 6 mm²

LPP 7.62 LPP 7.50

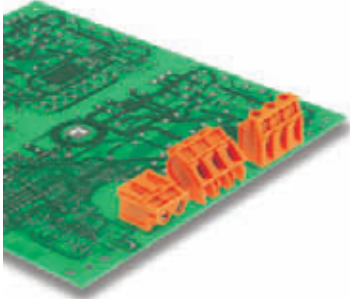

Test point, 1000 V, 32 A and 6 mm² conductor cross-section are feasible with this PCB terminal with proven clamping yoke connection at 7.50 and 7.62 mm pitch, conductor outlet direction 90° and 135°.

- 0.20 - 6.0mm² (IEC) / 26 - 12 AWG (UL)
- 1000 V (IEC) / 300 V (UL)
- 32 A (IEC) / 20 A (UL)

Derating curve

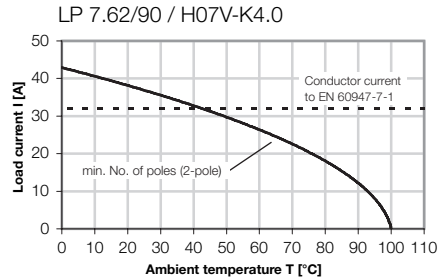

LPP 7.62/90 LPP 7.50/90

with test point

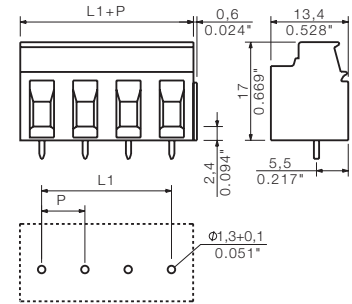

Technical data

Rated data to IEC 60664-1 / IEC 61984

Clamping range, max.	mm ²	0.13...6
Solid H05(07) V-U	mm ²	0.5...6
Stranded H07 V-R	mm ²	...6
Flexible H05(07) V-K	mm ²	0.5...4
Flexible with ferrule	mm ²	0.5...2,5
Ferrule with plastic collar	mm ²	0.5...2,5
Stripping length	mm	6
Screwdriver blade	mm	0.6 x 3.5
according to norm		DIN 5264
Tightening torque range	Nm	0.5...0.6

Rated current at ambient temperature

A	20°C	40°C
	32	32

Overvoltage category

Pollution severity	III	III	II
	3	2	2

Rated voltage	V	500	500	1000
Rated impulse voltage	kV	6	6	6

UL 1059 rated data - E60693

	B	C	D
Rated voltage	V	300	300
Rated current	A	20	10
AWG conductor		26-12	

CSA C22.2 rated data - LR12400 B

	B	C	D
Rated voltage	V	300	300
Rated current	A	20	10
AWG conductor		26-12	

Material data

Type of insulating material	PA
Flammability class acc. UL94	V-2
Contact base material	Cu alloy
Material of contact surface	tinned

Information

- Additional colours on request
- Rated current related to rated cross-section and min. No. of poles.
- Wire end ferrule without plastic collar to DIN 46228 pt 1
- Wire end ferrule with plastic collar to DIN 46228 pt 4
- P on drg. = pitch
- Rated data refer only to the component itself. Clearance and creepage distances to other components are to be designed in accordance with the relevant application standards.

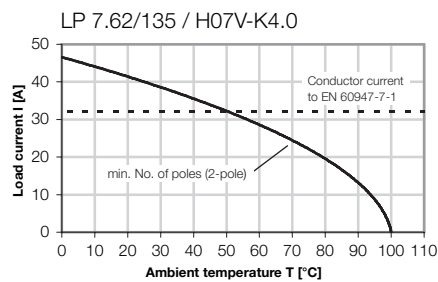

Ordering data

Solder pin length	3.2 mm
Colour	orange

Pitch 7.62 mm

Poles	L1 mm	(inch)	Qty.	Order No.	Order No.
2	7.62	(0.300)	100		1594480000
3	15.24	(0.600)	100		1594490000

Pitch 7.50 mm

Poles	L1 mm	(inch)	Qty.	Order No.	Order No.
2	7.50	(0.295)	100		1594440000
3	15.00	(0.591)	100		1594450000

LPP 7.62/135
LPP 7.50/135

with test point

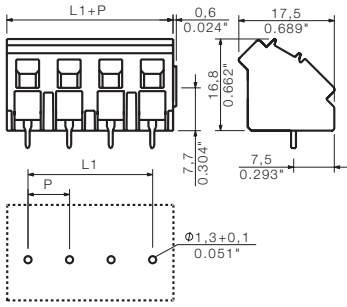

Accessories

Possible colors

Additional colours on request



Marking system

See chapter accessories



Ordering data

Solder pin length	3.2 mm
Colour	orange

Pitch 7.62 mm

Poles	L1 mm	(inch)	Qty.	Order No.	Order No.
2	7.62	(0.300)	100		1595790000
3	15.24	(0.600)	100		1595830000

Pitch 7.50 mm

Poles	L1 mm	(inch)	Qty.	Order No.	Order No.
2	7.50	(0.295)	100		1595770000
3	15.00	(0.591)	100		1595810000

Test plug

See chapter accessories



Screwdriver

See chapter accessories
Order No. 9008390000



Clamping yoke connection for cross-sections up to 6 mm²

LP 10.16
LP 10.00

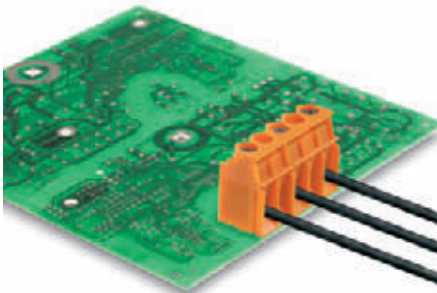

PCB terminal with proven clamping yoke connection in 10 and 10.16 mm pitch. Conductor outlet direction 90°. Suitable for conductor cross-sections up to 6.0 mm².

- 0.20 - 6.0mm² (IEC) / 26 - 12 AWG (UL)
- 1000 V (IEC) / 300 V (UL)
- 32 A (IEC) / 20 A (UL)

Derating curve

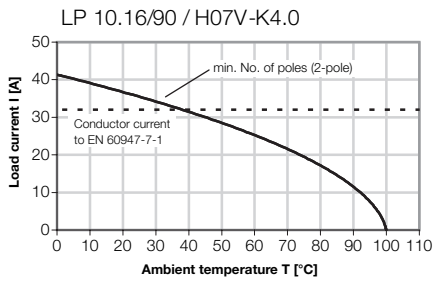

LP 10.16/90
LP 10.00/90

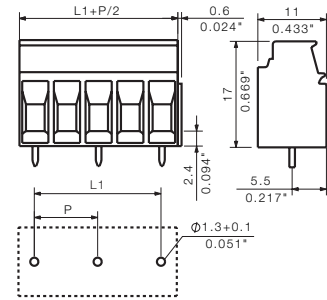

Technical data

Rated data to IEC 60664-1 / IEC 61984			
Clamping range, max.	mm ²	0.13...6	
Solid H05(07) V-U	mm ²	0.5...6	
Stranded H07 V-R	mm ²		
Flexible H05(07) V-K	mm ²	0.5...4	
Flexible with ferrule	mm ²	0.5...2,5	
Ferrule with plastic collar	mm ²	0.5...2,5	
Stripping length	mm	6	
Screwdriver blade	mm	0.6 x 3.5	
according to norm		DIN 5264	
Tightening torque range	Nm	0.5...0.6	
Rated current at ambient temperature			
	A	20°C	40°C
		32	32
Overvoltage category			
		III	III
Pollution severity			
		3	2
		2	2
Rated voltage	V	630	1000
Rated impulse voltage	kV	8	8
		8	8
UL 1059 rated data - E60693			
		B	C
Rated voltage	V	300	300
Rated current	A	20	10
AWG conductor		26-12	
CSA C22.2 rated data - LR12400 B			
		B	C
Rated voltage	V	300	300
Rated current	A	20	10
AWG conductor		26-12	
Material data			
Type of insulating material		PA	
Flammability class acc. UL94		V-2	
Contact base material		Cu alloy	
Material of contact surface		tinned	
Information			

- Additional colours on request
- Rated current related to rated cross-section and min. No. of poles.
- Wire end ferrule without plastic collar to DIN 46228 pt 1
- Wire end ferrule with plastic collar to DIN 46228 pt 4
- P on drg. = pitch
- Rated data refer only to the component itself. Clearance and creepage distances to other components are to be designed in accordance with the relevant application standards.

Ordering data

Solder pin length		3.2 mm	
Colour		orange	
Pitch 10.16 mm			
Poles	L1 mm (inch)	Qty.	Order No.
2	10.16 (0.400)	100	1845010000
3	20.32 (0.800)	50	1845020000
4	30.48 (1.200)	50	1845030000
Pitch 10 mm			
Poles	L1 mm (inch)	Qty.	Order No.
2	10.00 (0.394)	100	1693650000
3	20.00 (0.787)	50	1693660000
4	30.00 (1.181)	50	1692700000

Accessories

Possible colors

Additional colours on request

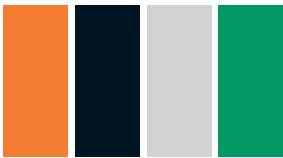

Marking system

See chapter accessories

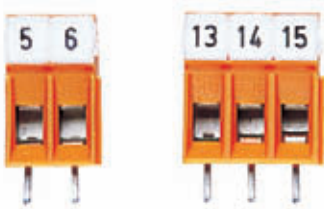

Marking and function indicator

See chapter accessories



Fuse element and disconnection element

See chapter accessories



Screwdriver

See chapter accessories
Order No. 9008390000



Clamping yoke connection for cross-sections up to 6 mm²

LL 9.52

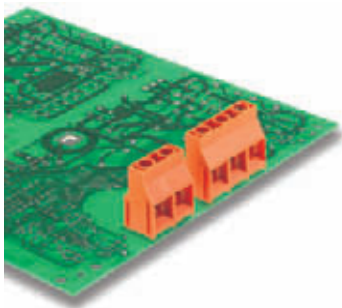

This PCB terminal provides connections for 1000 V, 32 A and 6 mm² conductor cross-section with established clamping yoke connection at 9.52 mm pitch, conductor outlet direction in 90° design

- 0.50 - 6.0 mm² (IEC) / 26 - 10 AWG (UL)
- 1000 V (IEC) / 300 V (UL)
- 32 A (IEC) / 30 A (UL)

Derating curve

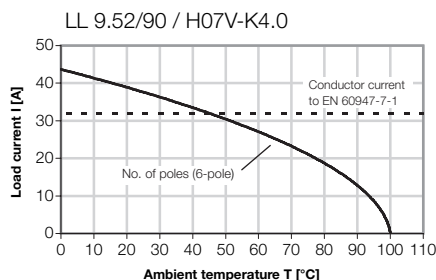

LL 9.52/90

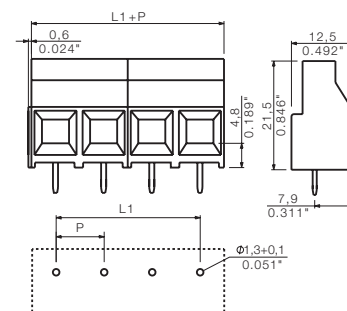

Technical data

Rated data to IEC 60664-1 / IEC 61984		
Clamping range, max.	mm ²	0.13...6
Solid H05(07) V-U	mm ²	0.5...6
Stranded H07 V-R	mm ²	
Flexible H05(07) V-K	mm ²	0.5...4
Flexible with ferrule	mm ²	0.5...2,5
Ferrule with plastic collar	mm ²	0.5...2,5
Stripping length	mm	7
Screwdriver blade	mm	0.8 x 4.0
according to norm		DIN 5264
Tightening torque range	Nm	0.5...0.6
Rated current at ambient temperature		
	A	20°C 40°C
		32 32
Overvoltage category		
		III III II
Pollution severity		
		3 2 2
Rated voltage	V	630 1000 1000
Rated impulse voltage	kV	8 8 8
UL 1059 rated data - E60693		
		B C D
Rated voltage	V	300 300 300
Rated current	A	30 30 10
AWG conductor		26-10
CSA C22.2 rated data - LR12400 B		
		B C D
Rated voltage	V	300 300 300
Rated current	A	30 30 10
AWG conductor		26-10
Material data		
Type of insulating material		PA
Flammability class acc. UL94		V-0
Contact base material		Cu alloy
Material of contact surface		tinned
Information		

- Rated current related to rated cross-section and min. No. of poles.
- Wire end ferrule without plastic collar to DIN 46228 pt 1
- Wire end ferrule with plastic collar to DIN 46228 pt 4
- P on drg. = pitch
- Rated data refer only to the component itself. Clearance and creepage distances to other components are to be designed in accordance with the relevant application standards.

Ordering data

Solder pin length	5.0 mm
Colour	orange

Pitch 9.52 mm				
Poles	L1 mm	(inch)	Qty.	Order No.
2	9.52	(0.375)	100	1724680000
3	19.04	(0.750)	100	1724690000

Accessories

Possible colors

Additional colours on request

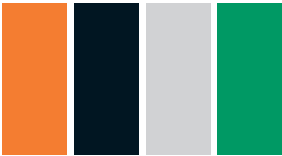

Marking strips

See chapter accessories



Screwdriver

See chapter accessories
Order No. 9008400000



Clamping yoke connection for cross-sections up to 10 mm²

GSE 10

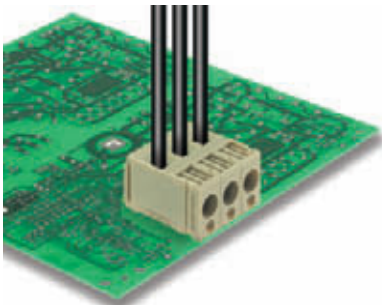

Low form PCB terminal for 10 mm² conductor cross-section and 57 A, with proven clamping yoke connection at 10 mm pitch, conductor outlet direction 180°.

- 0.50 - 10.0 mm² (IEC) / 26 - 8 AWG (UL)
- 1000 V (IEC) / 300 V (UL)
- 57 A (IEC) / 40 A (UL)

Derating curve

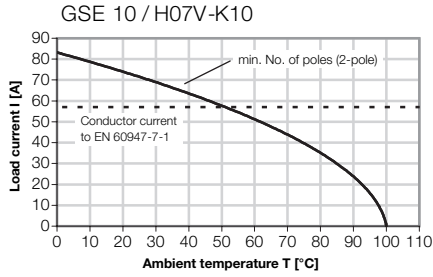

GSE 10/180

with test point

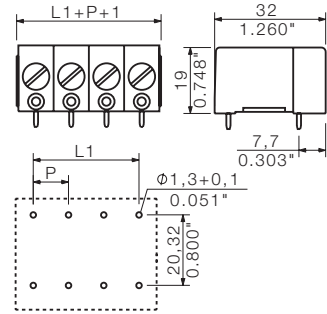

Technical data

Rated data to IEC 60664-1 / IEC 61984

Clamping range, max.	mm ²	0.13...10	
Solid H05(07) V-U	mm ²	0.5...10	
Stranded H07 V-R	mm ²	6...10	
Flexible H05(07) V-K	mm ²	0.5...10	
Flexible with ferrule	mm ²	0.75...4	
Ferrule with plastic collar	mm ²	0.75...4	
Stripping length	mm	10	
Screwdriver blade	mm	1.0 x 5.5	
according to norm		DIN 5264	
Tightening torque range	Nm	1.2...1.5	

Rated current at ambient temperature

	A	20°C	40°C
		57	57

Overvoltage category

	III	III	II
--	-----	-----	----

Pollution severity

	3	2	2
--	---	---	---

Rated voltage	V	400	500	1000
Rated impulse voltage	kV	6	6	6

UL 1059 rated data - E60693

		B	C	D
--	--	---	---	---

Rated voltage	V	300	150	300
Rated current	A	40	40	10
AWG conductor		26-8		

CSA C22.2 rated data - LR12400 B

		B	C	D
--	--	---	---	---

Rated voltage	V	300	300
Rated current	A	40	10
AWG conductor		26-8	

Material data

Type of insulating material	PA
Flammability class acc. UL94	V-2
Contact base material	E-Cu
Material of contact surface	tinned

Information

- Additional colours on request
- Rated current related to rated cross-section and min. No. of poles.
- Wire end ferrule without plastic collar to DIN 46228 pt 1
- Wire end ferrule with plastic collar to DIN 46228 pt 4
- P on drg. = pitch
- Rated data refer only to the component itself. Clearance and creepage distances to other components are to be designed in accordance with the relevant application standards.

Ordering data

Solder pin length	4.5 mm
Colour	grey

Pitch 10.16 mm

Poles	L1 mm	(inch)	Qty.	Order No.	Order No.
1	0.00	(0.000)	50		0478700000
2	10.00	(0.394)	20		9954140000
3	20.00	(0.787)	20		0478900000
4	30.00	(1.181)	20		1610220000
5	40.00	(1.575)	20		1761410000
6	50.00	(1.969)	20		9954160000
7	60.00	(2.362)	20		9958370000
8	70.00	(2.756)	20		9954170000
9	80.00	(3.150)	20		9958380000
10	90.00	(3.543)	20		9954180000

Accessories

Marking system

See chapter accessories

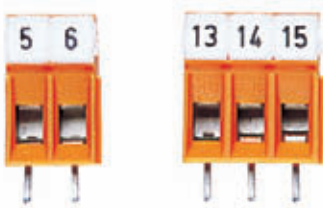

Test plug

See chapter accessories



Screwdriver

See chapter accessories
Order No. 9008410000



Clamping yoke connection for cross-sections up to 16 mm²

LU 10.16

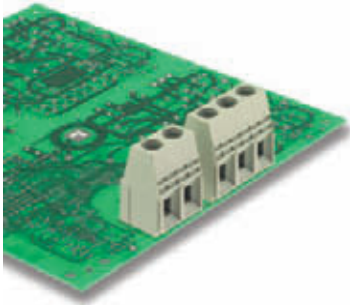

This PCB terminal provides connections for 76 A and 16 mm² conductor cross-section with established clamping yoke connection at 10.16 mm pitch, conductor outlet direction in 90° design

- 0.50 - 16.0mm² (IEC) / 26 - 6 AWG (UL)
- 1000 V (IEC) / 300 V (UL)
- 76A (IEC) / 60 A (UL)

Derating curve

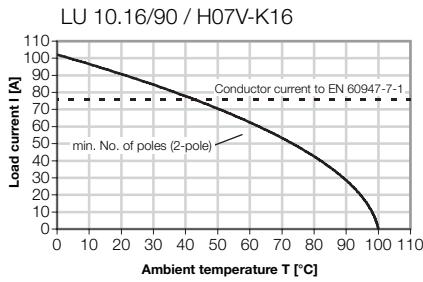

LU 10.16/90

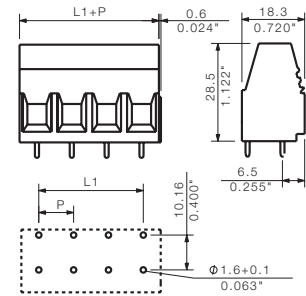

Technical data

Rated data to IEC 60664-1 / IEC 61984			
Clamping range, max.	mm ²	0.13...16	
Solid H05(07) V-U	mm ²	0.5...16	
Stranded H07 V-R	mm ²	6...16	
Flexible H05(07) V-K	mm ²	0.5...16	
Flexible with ferrule	mm ²	2.5...10	
Ferrule with plastic collar	mm ²	2.5...10	
Stripping length	mm	12	
Screwdriver blade	mm	1.0 x 5.5	
according to norm		DIN 5264	
Tightening torque range	Nm	1.2...1.5	
Rated current at ambient temperature			
	A	20°C	40°C
		76	74
Overvoltage category			
		III	III
Pollution severity			
		3	2
Rated voltage	V	690	690 1000
Rated impulse voltage	kV	6	6 4
UL 1059 rated data - E60693			
		B	C
Rated voltage	V	300	150 300
Rated current	A	60	60 10
AWG conductor		26-6	
CSA C22.2 rated data - LR12400 B			
		B	C
Rated voltage	V	300	150 300
Rated current	A	60	60 10
AWG conductor		22-6	
Material data			
Type of insulating material		Wemid (PA)	
Flammability class acc. UL94		V-0	
Contact base material		E-Cu	
Material of contact surface		tinned	
Information			

- Additional colours on request
- Rated current related to rated cross-section and min. No. of poles.
- Wire end ferrule without plastic collar to DIN 46228 pt 1
- Wire end ferrule with plastic collar to DIN 46228 pt 4
- P on drg. = pitch
- Rated data refer only to the component itself. Clearance and creepage distances to other components are to be designed in accordance with the relevant application standards.

Ordering data

Solder pin length	4.5 mm				
Colour	grey				
Pitch 10.16 mm					
Poles	L1 mm	(inch)	Qty.	Order No.	Order No.
2	10.16	(0.400)	20		1648310000
3	20.32	(0.800)	20		1648300000
4	30.48	(1.200)	20		9956390000
5	40.64	(1.600)	20		9956400000
6	50.80	(2.000)	20		9956410000
7	60.96	(2.400)	20		9956420000
8	71.12	(2.800)	20		9956430000
9	81.28	(3.200)	20		9956440000
10	91.44	(3.600)	20		9956450000

Accessories

Possible colors

Additional colours on request

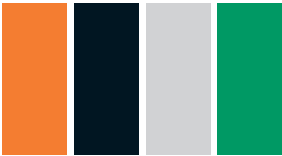

Marking strips

See chapter accessories



Marking system

See chapter accessories



Screwdriver

See chapter accessories
Order No. 9008410000



Clamping yoke connection for cross-sections up to 16 mm²

LUP 10.16

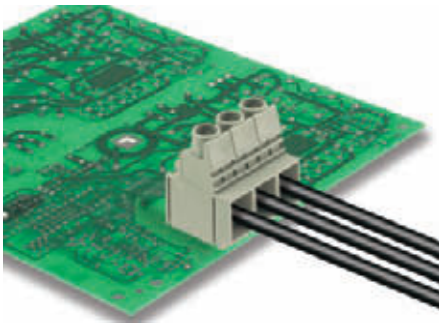

This PCB terminal provides connections for 1000 V, test point, 76 A and 16 mm² conductor cross-section with established clamping yoke connection at 10.16 mm pitch, conductor outlet direction in 90° design

- 0.50 - 16.0mm² (IEC) / 26 - 6 AWG (UL)
- 1000 V (IEC) / 300 V (UL)
- 76A (IEC) / 60 A (UL)

Derating curve

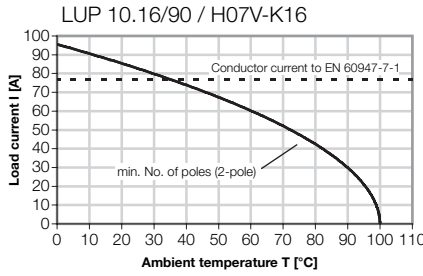

LUP 10.16/90

with test point

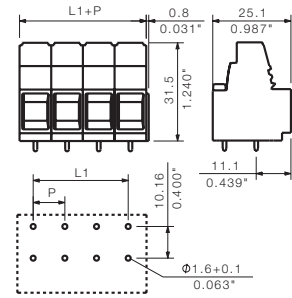

Technical data

Rated data to IEC 60664-1 / IEC 61984

Clamping range, max.	mm ²	0.13...16	
Solid H05(07) V-U	mm ²	0.5...16	
Stranded H07 V-R	mm ²	6...16	
Flexible H05(07) V-K	mm ²	0.5...16	
Flexible with ferrule	mm ²	2.5...10	
Ferrule with plastic collar	mm ²	2.5...10	
Stripping length	mm	12	
Screwdriver blade	mm	1.0 x 5.5	
according to norm		DIN 5264	
Tightening torque range	Nm	1.2...1.5	

Rated current at ambient temperature		20°C	40°C
	A	76	74

Overvoltage category		III	III	II
Pollution severity		3	2	2

Rated voltage	V	800	1000	1000
Rated impulse voltage	kV	8	8	6

UL 1059 rated data - E60693		B	C	D
Rated voltage	V	300	300	300
Rated current	A	60	60	10
AWG conductor		26-6		

CSA C22.2 rated data - LR12400 B		B	C	D
Rated voltage	V	300	300	300
Rated current	A	60	60	10
AWG conductor		22-6		

Material data		
Type of insulating material		Wemid (PA)
Flammability class acc. UL94		V-0
Contact base material		E-Cu
Material of contact surface		tinned

Information

- Additional colours on request
- Rated current related to rated cross-section and min. No. of poles.
- Wire end ferrule without plastic collar to DIN 46228 pt 1
- Wire end ferrule with plastic collar to DIN 46228 pt 4
- The data given under CSA relates to a cUL approval - E60693
- P on drg. = pitch
- Rated data refer only to the component itself. Clearance and creepage distances to other components are to be designed in accordance with the relevant application standards.

Ordering data

Solder pin length	3.2 mm
Colour	grey

Pitch 10.16 mm					
Poles	L1 mm	(inch)	Qty.	Order No.	Order No.
2	10.16	(0.400)	20	1839270000	
3	20.32	(0.800)	20	1839280000	
4	30.48	(1.200)	20	1839290000	
5	40.64	(1.600)	20	1839300000	
6	50.80	(2.000)	20	1839310000	
7	60.96	(2.400)	20	1839320000	
8	71.12	(2.800)	20	1839330000	
9	81.28	(3.200)	20	1839340000	

Accessories

Possible colors

Additional colours on request



Marking strips

See chapter accessories



Marking system

See chapter accessories



Test plug

See chapter accessories



Screwdriver

See chapter accessories
Order No. 9008410000



PCB Terminals

B

Clamping yoke connection for cross-sections up to 16 mm²

LUP 12.7

Derating curve

LUP 12.7/90

This PCB terminal provides connections for 1000 V, 76 A and 16 mm² conductor cross-section with established clamping yoke connection at 12.7 mm pitch, conductor outlet direction in 90° design

- 0.50 - 16.0mm² (IEC) / 26 - 6 AWG (UL)
- 1000 V (IEC) / 600 V (UL)
- 76A (IEC) / 63 A (UL)

LUP 12.7/90 / H07V-K16

with test point

Technical data

Rated data to IEC 60664-1 / IEC 61984

Clamping range, max.	mm ²	0.13...16	
Solid H05(07) V-U	mm ²	0.5...16	
Stranded H07 V-R	mm ²	6...16	
Flexible H05(07) V-K	mm ²	0.5...16	
Flexible with ferrule	mm ²	2.5...10	
Ferrule with plastic collar	mm ²	2.5...10	
Stripping length	mm	12	
Screwdriver blade	mm	1.0 x 5.5	
according to norm		DIN 5264	
Tightening torque range	Nm	1.2...1.5	

Rated current at ambient temperature

		20°C	40°C
A		76	74

Overvoltage category III III II

Pollution severity 3 2 2

Rated voltage	V	1000	1000	1000
Rated impulse voltage	kV	8	8	6

UL 1059 rated data - E60693

		B	C	D
Rated voltage	V	600	600	600
Rated current	A	63	63	5
AWG conductor		26-6		

CSA C22.2 rated data - LR12400 B

		B	C	D
Rated voltage	V	600	600	600
Rated current	A	63	63	5
AWG conductor		22-6		

Material data

Type of insulating material	Wemid (PA)
Flammability class acc. UL94	V-0
Contact base material	E-Cu
Material of contact surface	tinned

Information

- Additional colours on request
- Rated current related to rated cross-section and min. No. of poles.
- Wire end ferrule without plastic collar to DIN 46228 pt 1
- Wire end ferrule with plastic collar to DIN 46228 pt 4
- The data given under CSA relates to a cUL approval - E60693
- P on drg. = pitch
- Rated data refer only to the component itself. Clearance and creepage distances to other components are to be designed in accordance with the relevant application standards.

Ordering data

Solder pin length	3.2 mm
Colour	grey

Pitch 12.70 mm

Poles	L1 mm	(inch)	Qty.	Order No.	Order No.
2	12.70	(0.500)	20	1839180000	
3	25.40	(1.000)	20	1839190000	
4	38.10	(1.500)	20	1839200000	
5	50.80	(2.000)	20	1839210000	
6	63.50	(2.500)	20	1839220000	
7	76.20	(3.000)	20	1839230000	
8	88.90	(3.500)	20	1839240000	
9	101.60	(4.000)	20	1839250000	

B.38 Weidmüller

Accessories

Possible colors

Additional colours on request



Marking strips

See chapter accessories



Marking system

See chapter accessories

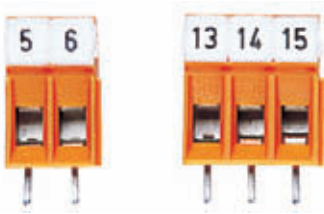

Test plug

See chapter accessories



Screwdriver

See chapter accessories
Order No. 9008410000



Accessories

Notes

Possible colors

Additional colours on request



Marking strips

See chapter accessories

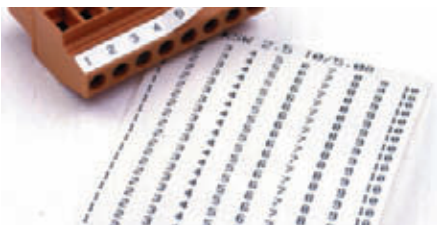

Marking system

See chapter accessories



Test plug

See chapter accessories



Screwdriver

See chapter accessories
Order No. 9008420000



LX 15.00

The PCB connection terminal for 25 mm² (AWG 4) enables PCB connections for 101 A (IEC) or 85 A (UL). The spacing of 15.00 mm enables operation in systems up to 1000 V (IEC) or 600 V (UL 1059 groups B and C).

Notes on installation:

When connecting conductors with a cross-section of up to 25 mm² / AWG 4, the torque can exert considerable forces on the PCB. In order to accommodate such forces, Weidmüller has devised a version with a flange fixing in addition to the standard model. If required, the PCB connection terminals can be screwed to the PCB or the enclosure via the flanges.

Here are two examples to show how this works:

Example 1 - LX 15.00 without fixing flanges.

In the vicinity of the LX 15.00 the PCB is supported on posts which are screwed to the PCB and affixed to the device enclosure.

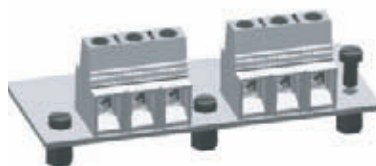

Example 2 - LX 15.00 with fixing flanges.

Slits are cut in the PCB at the positions of the LX 15.00 fixing flanges. The flanges are subsequently screwed to the PCB or the device enclosure using screws and posts.

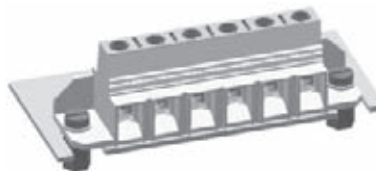

Clamping yoke connection for cross-sections up to 25 mm²

LX 15.00

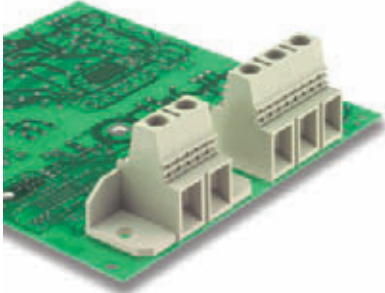

Fitted with flange for accommodating forces and fixing to PCB. 101 A, 1000 V and 25 mm² conductor cross-section are possible with this PCB terminal. Proven clamping yoke connection at 15.00 mm pitch, conductor outlet direction 90°, test pick-off

- 1.5 - 25 mm² (IEC) / 16 - 4 AWG (UL)
- 1000 V (IEC) / 600 V (UL)
- 101 A (IEC) / 85 A (UL)

Derating curve

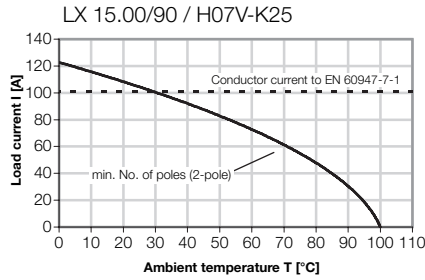

LXB 15.00/90

with fixing flange

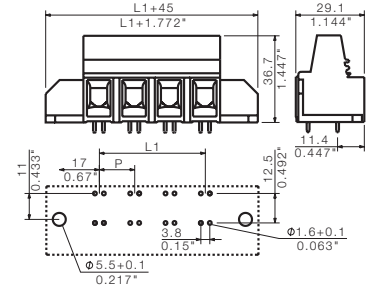

Technical data

Rated data to IEC 60664-1 / IEC 61984

Clamping range, max.	mm ²	1.31...25
Solid H05(07) V-U	mm ²	1.5...10
Stranded H07 V-R	mm ²	6...25
Flexible H05(07) V-K	mm ²	1.5...25
Flexible with ferrule	mm ²	1.5...16
Ferrule with plastic collar	mm ²	1.5...16
Stripping length	mm	16
Screwdriver blade	mm	1.2 x 6.5
according to norm		DIN 5264
Tightening torque range	Nm	2...4

Rated current at ambient temperature	20°C		40°C	
	A	101	91	

Overvoltage category	III	III	II
----------------------	-----	-----	----

Pollution severity	3	2	2
--------------------	---	---	---

Rated voltage	V	1000	1000	1000
---------------	---	------	------	------

Rated impulse voltage	kV	8	8	6
-----------------------	----	---	---	---

UL 1059 rated data - E60693

	B	C	D
--	---	---	---

Rated voltage	V	600	600	600
---------------	---	-----	-----	-----

Rated current	A	85	85	5
---------------	---	----	----	---

AWG conductor		16-4		
---------------	--	------	--	--

CSA C22.2 rated data - LR12400 B

	B	C	D
--	---	---	---

Rated voltage	V	600	600	600
---------------	---	-----	-----	-----

Rated current	A	85	85	5
---------------	---	----	----	---

AWG conductor		16-4		
---------------	--	------	--	--

Material data

Type of insulating material	Wemid (PA)
-----------------------------	------------

Flammability class acc. UL94	V-0
------------------------------	-----

Contact base material	E-Cu
-----------------------	------

Material of contact surface	tinned
-----------------------------	--------

Information

- Additional colours on request
- Rated current related to rated cross-section and min. No. of poles.
- Wire end ferrule without plastic collar to DIN 46228 pt 1
- Wire end ferrule with plastic collar to DIN 46228 pt 4
- P on drg. = pitch
- Rated data refer only to the component itself. Clearance and creepage distances to other components are to be designed in accordance with the relevant application standards.

Ordering data

Solder pin length	4.5 mm
Colour	grey

Pitch 15.00 mm

Poles	L1 mm	(inch)	Qty.	Order No.	Order No.
2	15.00	(0.591)	20		1783710000
3	30.00	(1.181)	20		1783720000
4	45.00	(1.772)	20		1783730000
5	60.00	(2.362)	20		1806470000
6	75.00	(2.953)	10		1783740000
8	105.00	(4.134)	10		1783750000

LXBL 15.00/1/90

with fixing flange

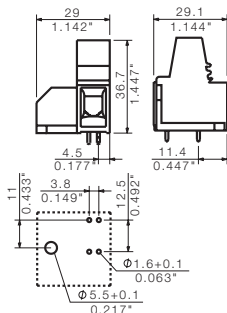

Ordering data

Solder pin length	4.5 mm
Colour	grey

Pitch 15.00 mm

Poles	L	1 mm (inch)	Qty.	Order No.	Order No.
1	0.00	(0.000)	20		1783700000

Accessories

Possible colors

Additional colours on request



Marking strips

See chapter accessories

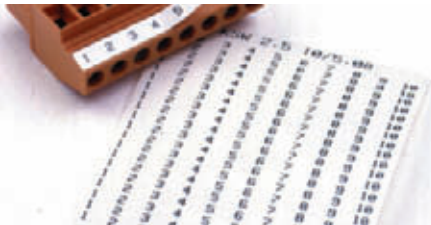

Marking system

See chapter accessories



Test plug

See chapter accessories



Screwdriver

See chapter accessories
Order No. 9008420000



Notes

LX 15.00

The PCB connection terminal for 25 mm² (AWG 4) enables PCB connections for 101 A (IEC) or 85 A (UL). The spacing of 15.00 mm enables operation in systems up to 1000 V (IEC) or 600 V (UL 1059 groups B and C).

Notes on installation:

When connecting conductors with a cross-section of up to 25 mm² / AWG 4, the torque can exert considerable forces on the PCB. In order to accommodate such forces, Weidmüller has devised a version with a flange fixing in addition to the standard model. If required, the PCB connection terminals can be screwed to the PCB or the enclosure via the flanges.

Here are two examples to show how this works:

Example 1 - LX 15.00 without fixing flanges. In the vicinity of the LX 15.00 the PCB is supported on posts which are screwed to the PCB and affixed to the device enclosure.

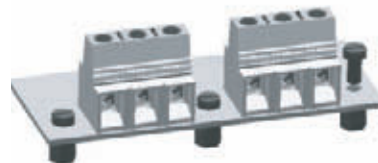

Example 2 - LX 15.00 with fixing flanges. Slits are cut in the PCB at the positions of the LX 15.00 fixing flanges. The flanges are subsequently screwed to the PCB or the device enclosure using screws and posts.

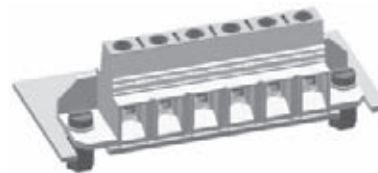

TOP connection

LPA-TOP

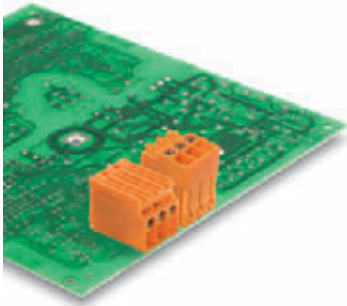

Conductor entry and screw connection in the same direction on this PCB terminal with 5.08 mm pitch for conductor cross-sections up to 2.5 mm². Conductor outlet direction 90° and 180°.

- 0.20 - 2.5mm² (IEC) / 26 - 14 AWG (UL)
- 500 V (IEC) / 300 V (UL)
- 24 A (IEC) / 10 A (UL)

Technical data

Rated data to IEC 60664-1 / IEC 61984

Clamping range, max.	mm ²	0.13...2.5
Solid H05(07) V-U	mm ²	0.5...2.5
Stranded H07 V-R	mm ²	
Flexible H05(07) V-K	mm ²	0.5...2.5
Flexible with ferrule	mm ²	0.5...1.5
Ferrule with plastic collar	mm ²	0.5...1.5
Stripping length	mm	13
Screwdriver blade	mm	0.6 x 3.5
according to norm		DIN 5264
Tightening torque range	Nm	0.4...0.5

Rated current at ambient temperature		20°C	40°C
	A	24	23

Overvoltage category	III	III	II
Pollution severity	3	2	2

Rated voltage	V	250	320	500
Rated impulse voltage	kV	4	4	4

UL 1059 rated data - E60693

		B	C	D
Rated voltage	V	300	300	
Rated current	A	10	10	
AWG conductor		26-14		

CSA C22.2 rated data - LR12400 B

		B	C	D
Rated voltage	V	300	300	
Rated current	A	10	10	
AWG conductor		26-14		

Material data

Type of insulating material	PA
Flammability class acc. UL94	V-2
Contact base material	Cu alloy
Material of contact surface	tinned

Information

- Additional colours on request
- Rated current related to rated cross-section and min. No. of poles.
- Wire end ferrule without plastic collar to DIN 46228 pt 1
- Wire end ferrule with plastic collar to DIN 46228 pt 4
- P on drg. = pitch
- Rated data refer only to the component itself. Clearance and creepage distances to other components are to be designed in accordance with the relevant application standards.

Derating curve

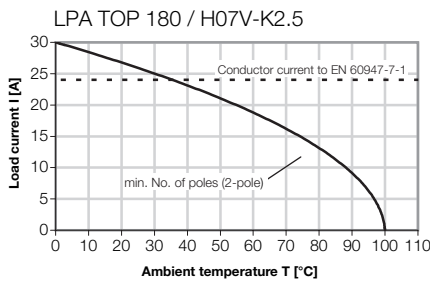
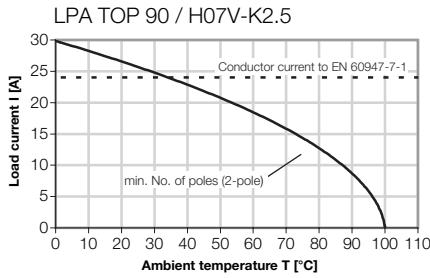

LPA TOP 1/90

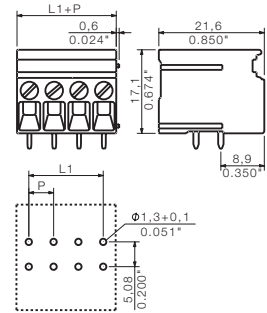

Ordering data

Solder pin length	3.2 mm
Colour	orange

Pitch 5.08 mm					
Poles	L1 mm	(inch)	Qty.	Order No.	Order No.
2	5.08	(0.200)	100		1535260000
3	10.16	(0.400)	100		1535360000

LPA TOP 1/180

Accessories

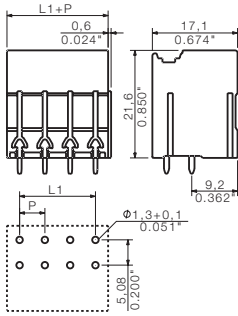

Possible colors

Additional colours on request



Marking system

See chapter accessories



Ordering data

Solder pin length 3.2 mm

Colour orange

Pitch 5.08 mm

Poles	L1 mm	(inch)	Qty.	Order No.	Order No.
2	5.08	(0.200)	100		1534860000
3	10.16	(0.400)	100		1534960000

Screwdriver

See chapter accessories
Order No. 9008390000



TOP connection

TOP 1.5 GS - 5.08

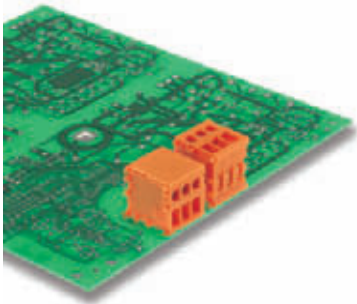

Conductor entry and screw connection in the same direction on this PCB terminal with 5.08 mm pitch for conductor cross-sections up to 2.5 mm². Conductor outlet direction 90° and 180°.

- 0.20 - 2.5 mm² (IEC) / 26 - 14 AWG (UL)
- 630 V (IEC) / 300 V (UL)
- 24 A (IEC) / 10 A (UL)

Technical data

Rated data to IEC 60664-1 / IEC 61984			
Clamping range, max.	mm ²	0.13...2.5	
Solid H05(07) V-U	mm ²	0.5...2.5	
Stranded H07 V-R	mm ²		
Flexible H05(07) V-K	mm ²	0.5...2.5	
Flexible with ferrule	mm ²	0.5...2.5	
Ferrule with plastic collar	mm ²	0.5...2.5	
Stripping length	mm	10	
Screwdriver blade	mm	0.6 x 3.5	
according to norm		DIN 5264	
Tightening torque range	Nm	0.4...0.5	
Rated current at ambient temperature			
	A	20°C	40°C
		24	21
Overvoltage category			
		III	III
Pollution severity			
		3	2
Rated voltage	V	250	320
Rated impulse voltage	kV	2.5	2.5
UL 1059 rated data - E60693			
		B	C
Rated voltage	V	300	300
Rated current	A	10	10
AWG conductor		26-14	
CSA C22.2 rated data - LR12400 B			
		B	C
Rated voltage	V	300	300
Rated current	A	10	10
AWG conductor		26-14	
Material data			
Type of insulating material		PA	
Flammability class acc. UL94		V-2	
Contact base material		CuZn	
Material of contact surface		tinned	
Information			

- Additional colours on request
- Rated current related to rated cross-section and min. No. of poles.
- Wire end ferrule without plastic collar to DIN 46228 pt 1
- Wire end ferrule with plastic collar to DIN 46228 pt 4
- Crimp form A for wire end ferrules with PZ 6/5 crimping tool are recommended for the largest cable sizes.
- P on drg. = pitch
- Rated data refer only to the component itself. Clearance and creepage distances to other components are to be designed in accordance with the relevant application standards.

Derating curve

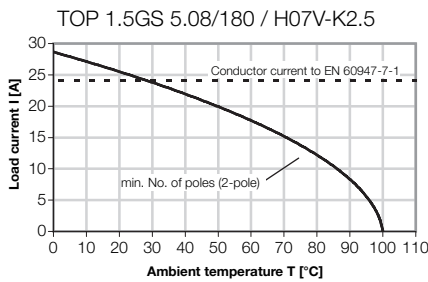
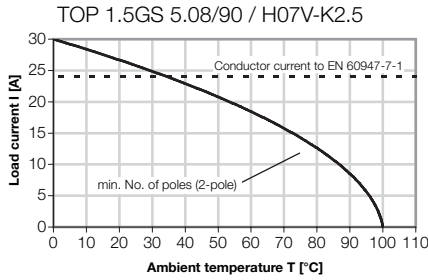

TOP 1.5GS/90-5.08

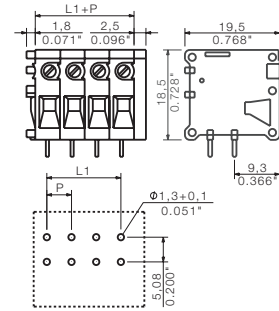

Ordering data

Solder pin length		3.5 mm	
Colour		orange	
Pitch 5.08 mm			
Poles	L1 mm (inch)	Qty.	Order No.
2	5.08 (0.200)	100	0641960000
3	10.16 (0.400)	100	0642060000
4	15.24 (0.600)	50	0642160000
5	20.32 (0.800)	50	1578820000
6	25.40 (1.000)	50	0593860000
7	30.48 (1.200)	50	0593960000
8	35.56 (1.400)	50	0594060000
9	40.64 (1.600)	50	0594160000
10	45.72 (1.800)	20	0642260000
11	50.80 (2.000)	50	0594260000
12	55.88 (2.200)	50	0594360000
13	60.96 (2.400)	50	0594460000
14	66.04 (2.600)	50	0594560000
15	71.12 (2.800)	50	0594660000
16	76.20 (3.000)	20	0642360000
17	81.28 (3.200)	20	0594760000
18	86.36 (3.400)	20	1707040000
19	91.44 (3.600)	10	0594960000
20	96.52 (3.800)	10	0595060000
21	101.60 (4.000)	10	0595160000
22	106.68 (4.200)	10	0595260000
23	111.76 (4.400)	10	0595360000
24	116.84 (4.600)	10	0595460000

TOP 1.5GS/180-5.08

Accessories

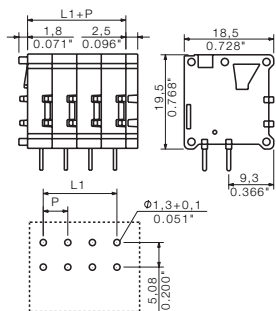

Possible colors

Additional colours on request



Fixing block

See chapter accessories



Ordering data

Solder pin length	4.5 mm
Colour	orange

Pitch 5.08 mm

Poles	L1 mm	(inch)	Qty.	Order No.	Order No.
2	5.08	(0.200)	100		0569960000
3	10.16	(0.400)	100		0570160000
4	15.24	(0.600)	50		0570360000
5	20.32	(0.800)	50		0597360000
6	25.40	(1.000)	50		0597460000
7	30.48	(1.200)	50		1695700000
8	35.56	(1.400)	25		0597660000
9	40.64	(1.600)	20		1474660000
10	45.72	(1.800)	20		0570560000
11	50.80	(2.000)	20		1474760000
12	55.88	(2.200)	20		0597960000
13	60.96	(2.400)	50		1724740000
14	66.04	(2.600)	20		0598160000
15	71.12	(2.800)	20		1782490000
16	76.20	(3.000)	20		0570760000
17	81.28	(3.200)	20		0598360000
18	86.36	(3.400)	10		0598460000
19	91.44	(3.600)	20		0598560000
20	96.52	(3.800)	20		0598660000
21	101.60	(4.000)	10		0598760000
22	106.68	(4.200)	10		0598860000
23	111.76	(4.400)	10		0598960000
24	116.84	(4.600)	10		0599060000

Marking system

See chapter accessories



Screwdriver

See chapter accessories
Order No. 9008390000



TOP connection

TOP 1.5GS 5.08 EX

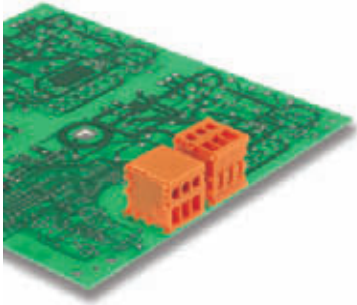

For potentially explosive areas, conductor entry and screw connection in one direction, PCB terminal in 5.08 mm pitch for conductor cross-sections up to 2.5 mm², conductor outlet direction 90° or 180°.

- 1.5 mm² / 14 AWG
- 176 V
- 12 A

Derating curve

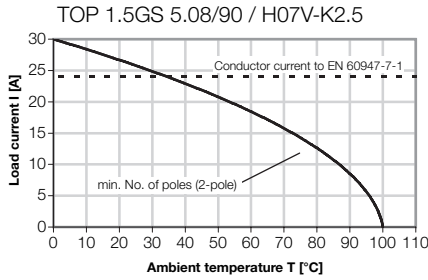

TOP 1.5GS/90-5.08 Ex e

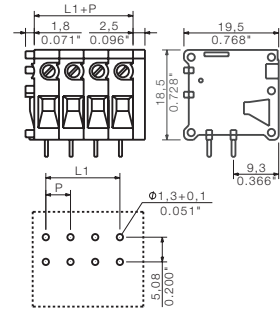

Technical data

Rated data to IEC 60664-1 / IEC 61984

Clamping range, max.	mm ²	
Solid H05(07) V-U	mm ²	
Stranded H07 V-R	mm ²	
Flexible H05(07) V-K	mm ²	
Flexible with ferrule	mm ²	
Ferrule with plastic collar	mm ²	
Stripping length	mm	
Screwdriver blade	mm	0.6 x 3.5
according to norm		DIN 5264
Tightening torque range	Nm	0.4...0.5

Rated current at ambient temperature	20°C	40°C
	A	

Overvoltage category	III	III	II
Pollution severity	3	2	2

Rated voltage	V	176
Rated impulse voltage	kV	

Rated data Ex e - DEMKO 03 ATEX 134439 U

Rated voltage	V	176
Rated current	A	12
Clamping range	mm ² /AWG	0.13...1.5 / 26...14

@ CSA C22.2 rated data - LR12400 B B C D

Rated voltage	V	
Rated current	A	
AWG conductor		

Type of insulating material	PA
Flammability class acc. UL94	V-2
Contact base material	CuZn
Material of contact surface	tinned

Information

- P on drg. = pitch
- Rated data refer only to the component itself. Clearance and creepage distances to other components are to be designed in accordance with the relevant application standards.

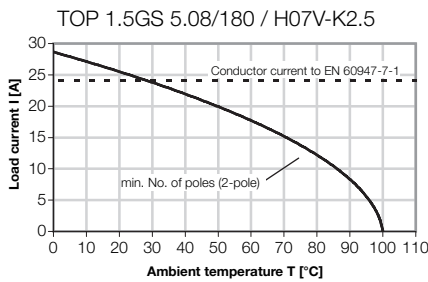

Ordering data

Solder pin length	3.5 mm				
Colour	orange				
Pitch 5.08 mm					
Poles	L1 mm	(inch)	Qty.	Order No.	Order No.
2	5.08	(0.200)	100		1850120000
3	10.16	(0.400)	100		1850130000
4	15.24	(0.600)	50		1850140000
5	20.32	(0.800)	50		1850150000
6	25.40	(1.000)	50		1850160000
7	30.48	(1.200)	50		1850170000
8	35.56	(1.400)	50		1850180000
9	40.64	(1.600)	50		1850190000
10	45.72	(1.800)	20		1850200000
11	50.80	(2.000)	50		1850210000
12	55.88	(2.200)	50		1850220000

TOP 1.5GS/180-5.08 Ex e

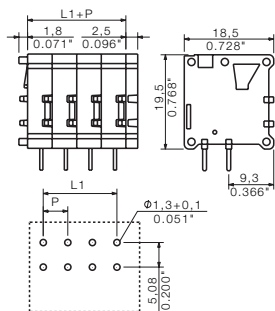

Ordering data

Solder pin length		4.5 mm			
Colour		orange			
Pitch 5.08 mm					
Poles	L1 mm	(inch)	Qty.	Order No.	Order No.
2	5.08	(0.200)	100		1850230000
3	10.16	(0.400)	100		1850240000
4	15.24	(0.600)	50		1850250000
5	20.32	(0.800)	50		1850260000
6	25.40	(1.000)	50		1850270000
7	30.48	(1.200)	50		1850280000
8	35.56	(1.400)	25		1850290000
9	40.64	(1.600)	20		1850300000
10	45.72	(1.800)	20		1850310000
11	50.80	(2.000)	20		1850320000
12	55.88	(2.200)	20		1850330000

Accessories

Note

Ex e / ATEX

The old Explosive Atmospheres and Gassy Mines Directive 76/117/EEC was superseded by the new directive 94/9/EC, also known as ATEX 95 (ATEX: ATmosphere EXplosive = potentially explosive atmosphere), on 1 July 2003. Only the new directive is now valid, which is one of the so-called "New Approach" directives. It applies in all the countries of the European Union plus Iceland, Liechtenstein and Norway. In all these countries the directive applies to the sale and operation of products that have been specially developed for use in potentially explosive atmospheres in which gases, vapours, mists or dusts prevail. A new development is the inclusion of mining operations and purely mechanical devices. The ATEX directive had been in force since March 1996, but its use up until 30 June 2003 (transitional period) was optional and existing directives remained applicable as well. Since 1 July 2003 all new installations and equipment for use in potentially explosive areas must comply with the ATEX directive and be certified accordingly, however the previous breakdown into zones (Zone 0, 1 or 2) and classes of protection (e.g. "i": intrinsic safety, "e": increased safety) is still applicable.

Fixing block

See chapter accessories



Marking system

See chapter accessories



Screwdriver

See chapter accessories
Order No. 9008390000



TOP connection

TOP 1.5 GS - 7.62

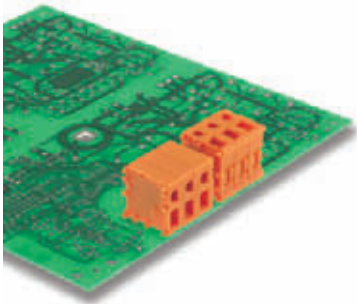

Conductor entry and screw connection in the same direction on this PCB terminal with 7.62 mm pitch for conductor cross-sections up to 2.5 mm². Conductor outlet direction 90° and 180°.

- 0.20 - 2.5 mm² (IEC) / 26 - 14 AWG (UL)
- 1000 V (IEC) / 300 V (UL)
- 24 A (IEC) / 10 A (UL)

Technical data

Rated data to IEC 60664-1 / IEC 61984

Clamping range, max.	mm ²	0.13...2.5	
Solid H05(07) V-U	mm ²	0.5...2.5	
Stranded H07 V-R	mm ²		
Flexible H05(07) V-K	mm ²	0.5...2.5	
Flexible with ferrule	mm ²	0.5...2.5	
Ferrule with plastic collar	mm ²	0.5...2.5	
Stripping length	mm	10	
Screwdriver blade	mm	0.6 x 3.5	
according to norm		DIN 5264	
Tightening torque range	Nm	0.4...0.5	

Rated current

at ambient temperature		20°C	40°C
	A	24	21

Overvoltage category

	III	III	II
--	-----	-----	----

Pollution severity

	3	2	2
--	---	---	---

Rated voltage	V	400	630	1000
Rated impulse voltage	kV	4	4	4

UL 1059 rated data - E60693

		B	C	D
Rated voltage	V	300	300	
Rated current	A	10	10	
AWG conductor		26-14		

CSA C22.2 rated data - LR12400 B

		B	C	D
Rated voltage	V	300	300	
Rated current	A	10	10	
AWG conductor		26-14		

Material data

Type of insulating material	PA
Flammability class acc. UL94	V-2
Contact base material	CuZn
Material of contact surface	tinned

Information

- Additional colours on request
- Rated current related to rated cross-section and min. No. of poles.
- Wire end ferrule without plastic collar to DIN 46228 pt 1
- Wire end ferrule with plastic collar to DIN 46228 pt 4
- Crimp form A for wire end ferrules with PZ 6/5 crimping tool are recommended for the largest cable sizes.
- P on drg. = pitch
- Rated data refer only to the component itself. Clearance and creepage distances to other components are to be designed in accordance with the relevant application standards.

Derating curve

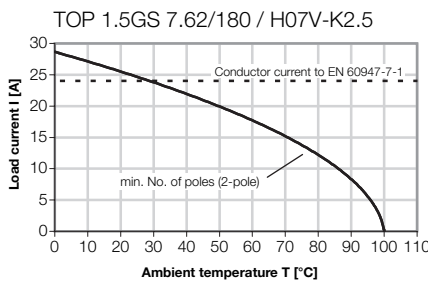
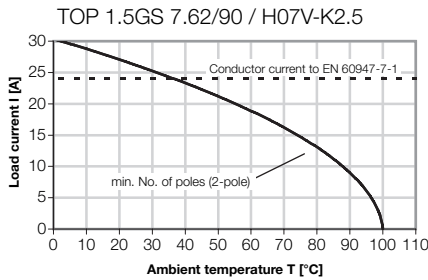

TOP 1.5GS/90-7.62

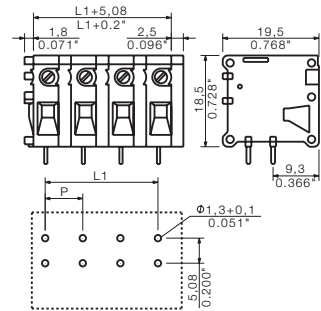

Ordering data

Solder pin length	3.5 mm				
Colour	orange				
Pitch 7.62 mm					
Poles	L1 mm	(inch)	Qty.	Order No.	Order No.
2	7.62	(0.300)	100		0393360000
3	15.24	(0.600)	100		0393460000
4	22.86	(0.900)	50		0393560000
5	30.48	(1.200)	25		0393660000
6	38.10	(1.500)	20		1683990000
7	45.72	(1.800)	20		1647310000
8	53.34	(2.100)	20		0642460000
9	60.96	(2.400)	20		0393960000
10	68.58	(2.700)	20		0642560000
11	76.20	(3.000)	20		0394060000
12	83.82	(3.300)	20		0394160000

TOP 1.5GS/180-7.62

Accessories

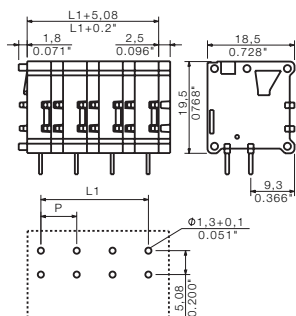
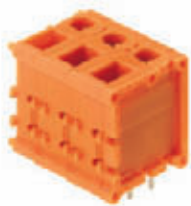

Possible colors

Additional colours on request



Fixing block

See chapter accessories



Ordering data

Solder pin length	4.5 mm
Colour	orange

Pitch 7.62 mm

Poles	L1 mm	(inch)	Qty.	Order No.	Order No.
2	7.62	(0.300)	100		0391360000
3	15.24	(0.600)	50		0391460000
4	22.86	(0.900)	50		0391560000
5	30.48	(1.200)	25		1490460000
6	38.10	(1.500)	25		1597060000
7	45.72	(1.800)	25		1597070000
8	53.34	(2.100)	20		0570960000
9	60.96	(2.400)	20		1597080000
10	68.58	(2.700)	20		0571160000
11	76.20	(3.000)	20		1597090000
12	83.82	(3.300)	20		0392160000

Marking system

See chapter accessories



Screwdriver

See chapter accessories
Order No. 9008390000



TOP connection

TOP 1.5GS 7.62 EX

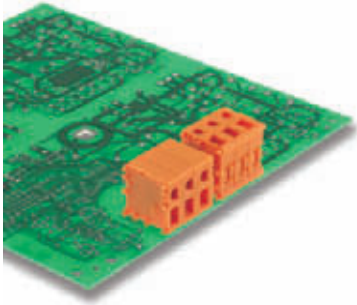

For potentially explosive areas, conductor entry and screw connection in one direction, PCB terminal in 5.08 mm pitch for conductor cross-sections up to 2.5 mm², conductor outlet direction 90° or 180°.

- 1.5 mm² / 14 AWG
- 275 V
- 12 A

Derating curve

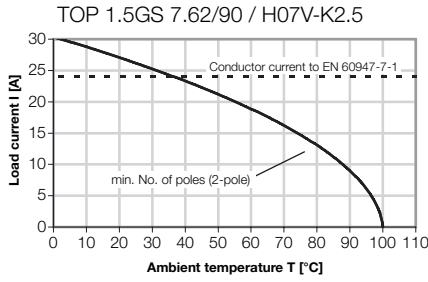

TOP 1.5GS/90-7.62 Ex e

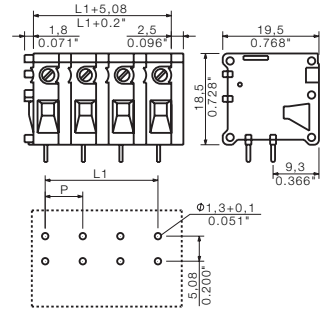

Technical data

Rated data to IEC 60664-1 / IEC 61984			
Clamping range, max.	mm ²		
Solid H05(07) V-U	mm ²		
Stranded H07 V-R	mm ²		
Flexible H05(07) V-K	mm ²		
Flexible with ferrule	mm ²		
Ferrule with plastic collar	mm ²		
Stripping length	mm		
Screwdriver blade	mm	0.6 x 3.5	
according to norm		DIN 5264	
Tightening torque range	Nm	0.4...0.5	
Rated current at ambient temperature	A	20°C	40°C
		III	III
		3	2
Overvoltage category		III	II
Pollution severity		3	2
Rated voltage	V		
Rated impulse voltage	kV		
Rated data Ex e - DEMKO 03 ATEX 134439 U			
Rated voltage	V	275	
Rated current	A	12	
Clamping range	mm ² /AWG	0.13...1.5/26...14	
@ CSA C22.2 rated data - LR12400 B B C D			
Rated voltage	V		
Rated current	A		
AWG conductor			
Material data			
Type of insulating material		PA	
Flammability class acc. UL94		V-2	
Contact base material		CuZn	
Material of contact surface		tinned	
Information			
• P on drg. = pitch			
• Rated data refer only to the component itself. Clearance and creepage distances to other components are to be designed in accordance with the relevant application standards.			

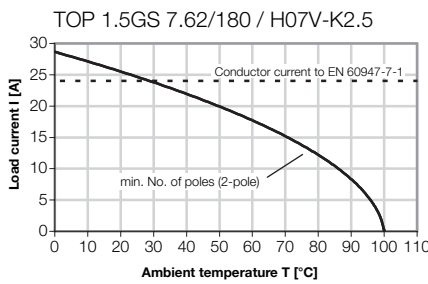

Ordering data

Solder pin length		3.5 mm		
Colour		orange		
Pitch 7.62 mm				
Poles	L1 mm (inch)	Qty.	Order No.	Order No.
2	7.62 (0.300)	100		1850340000
3	15.24 (0.600)	100		1850350000
4	22.86 (0.900)	50		1850360000
5	30.48 (1.200)	25		1850370000
6	38.10 (1.500)	20		1850380000
7	45.72 (1.800)	20		1850390000
8	53.34 (2.100)	20		1850400000
9	60.96 (2.400)	20		1850410000
10	68.58 (2.700)	20		1850420000
11	76.20 (3.000)	20		1850430000
12	83.82 (3.300)	20		1850440000

TOP 1.5GS/180-7.62 Ex e

Accessories

Note

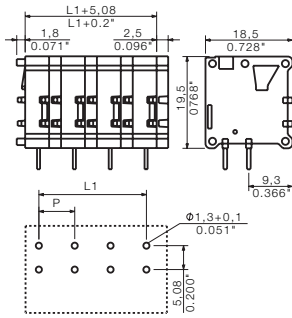

Ordering data

Solder pin length	4.5 mm
Colour	orange

Pitch 7.62 mm

Poles	L1 mm	(inch)	Qty.	Order No.	Order No.
2	7.62	(0.300)	100		1850450000
3	15.24	(0.600)	50		1850460000
4	22.86	(0.900)	50		1850470000
5	30.48	(1.200)	25		1850480000
6	38.10	(1.500)	25		1850490000
7	45.72	(1.800)	25		1850500000
8	53.34	(2.100)	20		1850510000
9	60.96	(2.400)	20		1850520000
10	68.58	(2.700)	20		1850530000
11	76.20	(3.000)	20		1850540000
12	83.82	(3.300)	20		1850550000

Fixing block

See chapter accessories



Marking system

See chapter accessories



Screwdriver

See chapter accessories
Order No. 9008390000



Ex e / ATEX

The old Explosive Atmospheres and Gassy Mines Directive 76/117/EEC was superseded by the new directive 94/9/EC, also known as ATEX 95 (ATEX: ATmosphère EXplosive = potentially explosive atmosphere), on 1 July 2003. Only the new directive is now valid, which is one of the so-called "New Approach" directives. It applies in all the countries of the European Union plus Iceland, Liechtenstein and Norway. In all these countries the directive applies to the sale and operation of products that have been specially developed for use in potentially explosive atmospheres in which gases, vapours, mists or dusts prevail. A new development is the inclusion of mining operations and purely mechanical devices. The ATEX directive had been in force since March 1996, but its use up until 30 June 2003 (transitional period) was optional and existing directives remained applicable as well. Since 1 July 2003 all new installations and equipment for use in potentially explosive areas must comply with the ATEX directive and be certified accordingly, however the previous breakdown into zones (Zone 0, 1 or 2) and classes of protection (e.g. "i": intrinsic safety, "e": increased safety) is still applicable.

TOP connection

TOP 4 GS - 6.35

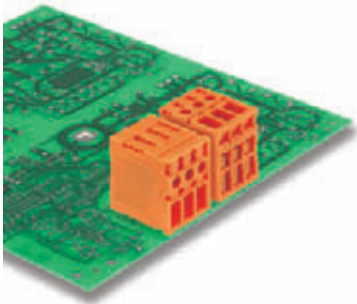

Conductor entry and screw connection in the same direction on this PCB terminal with 6.35 mm pitch for conductor cross-sections up to 6.0 mm². Conductor outlet direction 90° and 180°.

- 0.20 - 6.0 mm² (IEC) / 26 - 10 AWG (UL)
- 320 V (IEC) / 300 V (UL)
- 32 A (IEC) / 30 A (UL)

Technical data

Rated data to IEC 60664-1 / IEC 61984

Clamping range, max.	mm ²	0.13...6
Solid H05(07) V-U	mm ²	0.5...6
Stranded H07 V-R	mm ²	
Flexible H05(07) V-K	mm ²	0.5...4
Flexible with ferrule	mm ²	0.5...4
Ferrule with plastic collar	mm ²	0.5...4
Stripping length	mm	13
Screwdriver blade	mm	0.6 x 3.5
according to norm		DIN 5264
Tightening torque range	Nm	0.5...0.6

Rated current

at ambient temperature		20°C	40°C
	A	32	32

Overvoltage category

	III	III	II
--	-----	-----	----

Pollution severity

	3	2	2
--	---	---	---

Rated voltage	V	320	320	320
Rated impulse voltage	kV	2.5	2.5	2.5

UL 1059 rated data - E60693

		B	C	D
Rated voltage	V	300	300	
Rated current	A	30	10	
AWG conductor		26-10		

CSA C22.2 rated data - LR12400 B

		B	C	D
Rated voltage	V	300	300	
Rated current	A	30	10	
AWG conductor		26-10		

Material data

Type of insulating material	PA
Flammability class acc. UL94	V-2
Contact base material	E-Cu
Material of contact surface	tinned

Information

- Additional colours on request
- Rated current related to rated cross-section and min. No. of poles.
- Wire end ferrule without plastic collar to DIN 46228 pt 1
- Wire end ferrule with plastic collar to DIN 46228 pt 4
- P on drg. = pitch
- Rated data refer only to the component itself. Clearance and creepage distances to other components are to be designed in accordance with the relevant application standards.

Derating curve

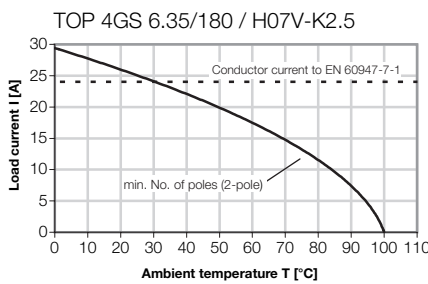
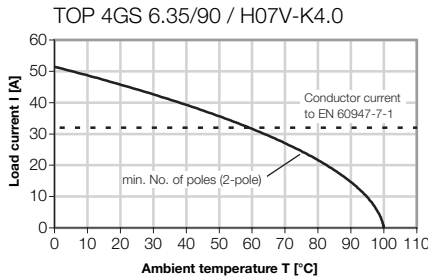

TOP 4GS/90-6.35

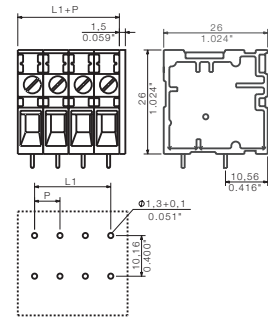

Ordering data

Solder pin length	3.5 mm				
Colour	orange				
Pitch 6.35 mm					
Poles	L1 mm	(inch)	Qty.	Order No.	Order No.
2	6.35	(0.250)	100		1401760000
3	12.70	(0.500)	100		1650300000
4	19.05	(0.750)	50		1786030000
5	25.40	(1.000)	50		1786040000
6	31.75	(1.250)	50		1786050000
7	38.10	(1.500)	50		1786060000
8	44.45	(1.750)	50		1667910000
9	50.80	(2.000)	50		1786070000
10	57.15	(2.250)	50		1786080000
11	63.50	(2.500)	50		1786090000
12	69.85	(2.750)	50		1786100000

TOP 4GS/180-6.35

Accessories

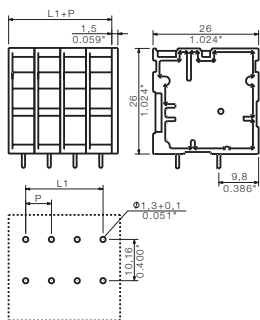

Possible colors

Additional colours on request



Marking system

See chapter accessories

Ordering data

Solder pin length	3.5 mm
Colour	orange

Pitch 6.35 mm

Poles	L1 mm	(inch)	Qty.	Order No.	Order No.
2	6.35	(0.250)	100		1786190000
3	12.70	(0.500)	100		1786200000
4	19.05	(0.750)	50		1786210000
5	25.40	(1.000)	50		1786220000
6	31.75	(1.250)	50		1786230000
7	38.10	(1.500)	50		1786240000
8	44.45	(1.750)	50		1786250000
9	50.80	(2.000)	50		1786260000
10	57.15	(2.250)	50		1786270000
11	63.50	(2.500)	50		1786280000
12	69.85	(2.750)	50		1786290000



Screwdriver

See chapter accessories
Order No. 9008390000



TOP connection

TOP 4 GS - 7.62

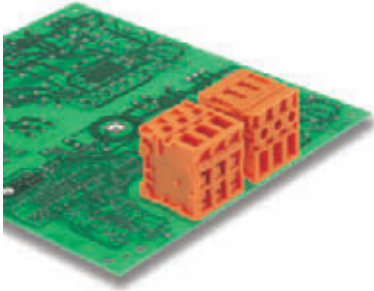

Conductor entry and screw connection in the same direction on this PCB terminal with 7.62 mm pitch for conductor cross-sections up to 6.0 mm². Conductor outlet direction 90° and 180°.

- 0.20 - 6.0 mm² (IEC) / 26 - 10 AWG (UL)
- 1000 V (IEC) / 300 V (UL)
- 32 A (IEC) / 30 A (UL)

Technical data

Rated data to IEC 60664-1 / IEC 61984

Clamping range, max.	mm ²	0.13...6	
Solid H05(07) V-U	mm ²	0.5...6	
Stranded H07 V-R	mm ²		
Flexible H05(07) V-K	mm ²	0.5...4	
Flexible with ferrule	mm ²	0.5...4	
Ferrule with plastic collar	mm ²	0.5...4	
Stripping length	mm	13	
Screwdriver blade	mm	0.6 x 3.5	
according to norm		DIN 5264	
Tightening torque range	Nm	0.5...0.6	

Rated current

at ambient temperature		20°C	40°C
	A	32	32

Overvoltage category

	III	III	II
Pollution severity	3	2	2

Rated voltage	V	500	630	1000
Rated impulse voltage	kV	4	4	4

UL 1059 rated data - E60693

	B	C	D
Rated voltage	V	300	300
Rated current	A	30	10
AWG conductor		26-10	

CSA C22.2 rated data - LR12400 B

	B	C	D
Rated voltage	V	300	300
Rated current	A	30	10
AWG conductor		26-10	

Material data

Type of insulating material	PA
Flammability class acc. UL94	V-2
Contact base material	E-Cu
Material of contact surface	tinned

Information

- Additional colours on request
- Rated current related to rated cross-section and min. No. of poles.
- Wire end ferrule without plastic collar to DIN 46228 pt 1
- Wire end ferrule with plastic collar to DIN 46228 pt 4
- P on drg. = pitch
- Rated data refer only to the component itself. Clearance and creepage distances to other components are to be designed in accordance with the relevant application standards.

Derating curve

TOP 4GS 7.62/90 / H07V-K4.0

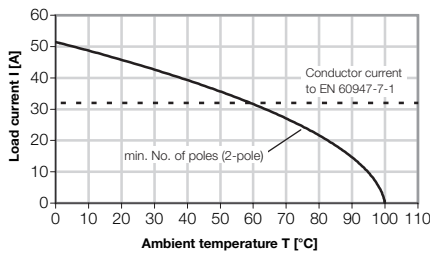

TOP 4GS 7.62/180 / H07V-K2.5

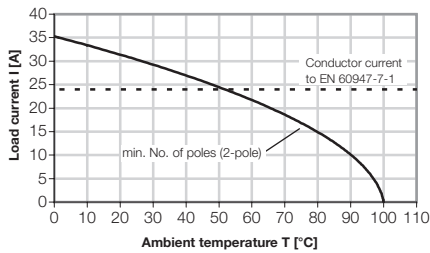

TOP 4GS/90-7.62

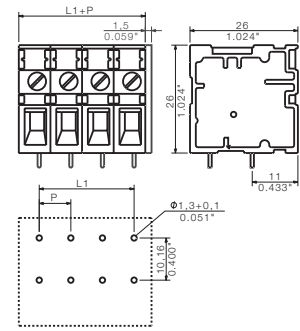

Ordering data

Solder pin length		3.5 mm	
Colour		orange	
Pitch 7.62 mm			
Poles	L1 mm (inch)	Qty.	Order No.
2	7.62 (0.300)	50	0289660000
3	15.24 (0.600)	50	0289760000
4	22.86 (0.900)	50	0290160000
5	30.48 (1.200)	50	1698740000
6	38.10 (1.500)	50	1786410000
7	45.72 (1.800)	50	1647300000
8	53.34 (2.100)	50	1786420000
9	60.96 (2.400)	50	1786430000
10	68.58 (2.700)	50	1786440000
11	76.20 (3.000)	50	1759860000
12	83.82 (3.300)	50	1786450000

TOP 4GS/180-7.62

Accessories

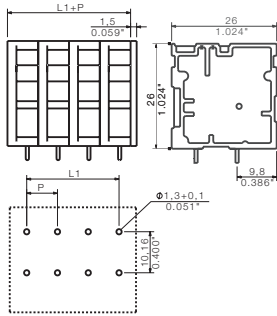

Possible colors

Additional colours on request



Marking system

See chapter accessories

Ordering data

Solder pin length	3.5 mm
Colour	orange

Pitch 7.62 mm

Poles	L1 mm	(inch)	Qty.	Order No.	Order No.
2	7.62	(0.300)	50		0298360000
3	15.24	(0.600)	50		0298460000
4	22.86	(0.900)	50		0298560000
5	30.48	(1.200)	50		1786540000
6	38.10	(1.500)	50		1494560000
7	45.72	(1.800)	50		1786550000
8	53.34	(2.100)	50		1786560000
9	60.96	(2.400)	50		1571700000
10	68.58	(2.700)	50		1786570000
11	76.20	(3.000)	50		1786580000
12	83.82	(3.300)	50		1749170000

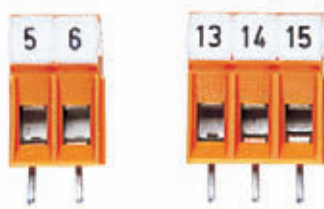

Screwdriver

See chapter accessories
Order No. 9008390000



Leaf spring connection

PS 3.5



Very small and compact PCB terminal with leaf spring connection in 3.5 mm pitch, with a conductor outlet direction 90° and suitable for conductor cross-sections up to 1.5 mm².

- 0.20 - 1.5mm² (IEC) / 28 - 16 AWG (UL)
- 320 V (IEC) / 300 V (UL)
- 17.5 A (IEC) / 10 A (UL)

Derating curve

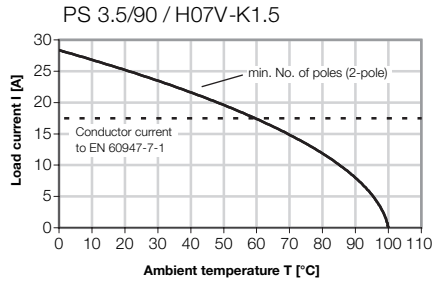

Technical data

Rated data to IEC 60664-1 / IEC 61984

Clamping range, max.	mm²	0.08...1.5
Solid H05(07) V-U	mm²	0.5...1.5
Stranded H07 V-R	mm²	
Flexible H05(07) V-K	mm²	0.5...1.5
Flexible with ferrule	mm²	0.25...0.75
Ferrule with plastic collar	mm²	0.25...0.75
Stripping length	mm	4
Screwdriver blade according to norm	mm	0.4 x 2.5
Tightening torque range	Nm	0.2...0.25

Rated current

at ambient temperature	20°C	40°C
A	17.5	17.5

Overvoltage category

Pollution severity	III	III	II
Rated voltage	V	160	160 320
Rated impulse voltage	kV	2.5	2.5 2.5

UL 1059 rated data - E60693

	B	C	D
Rated voltage	V	300	
Rated current	A	10	
AWG conductor		28-16	

@ CSA C22.2 rated data - LR12400 B

	B	C	D
Rated voltage	V	300	
Rated current	A	10	
AWG conductor		28-16	

Material data

Type of insulating material	PA
Flammability class acc. UL94	V-0
Contact base material	Cu alloy
Material of contact surface	tinned

Information

- Rated current related to rated cross-section and min. No. of poles.
- Wire end ferrule without plastic collar to DIN 46228 pt 1
- Wire end ferrule with plastic collar to DIN 46228 pt 4
- The data given under CSA relates to a cUL approval - E60693
- P on drg. = pitch
- Rated data refer only to the component itself. Clearance and creepage distances to other components are to be designed in accordance with the relevant application standards.

PS 3.5/90

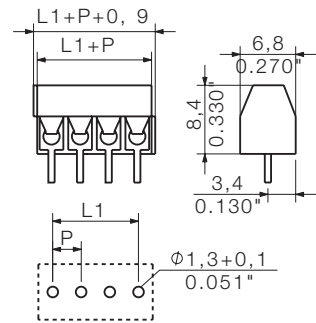

Ordering data

Solder pin length	3.5 mm
Colour	black

Pitch 3.50 mm

Poles	L1 mm (inch)	Qty.	Order No.	Order No.
2	3.50 (0.138)	100		1811180000
3	7.00 (0.276)	100		1811190000

Accessories

Possible colors

Additional colours on request

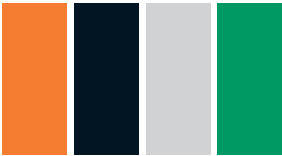

Marking strips

See chapter accessories



Screwdriver

See chapter accessories
Order No. 9008370000



Leaf spring connection

PM 5.08
PM 5.00

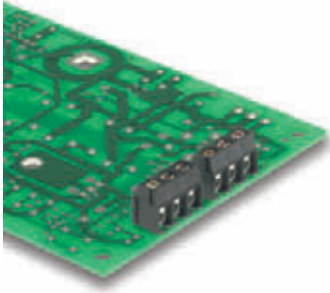

PCB terminal with leaf spring connection in 5.00 and 5.08 mm pitch. Conductor outlet direction 90°. Suitable for conductor cross-sections up to 2.5 mm².

- 0.20 - 2.5 mm² (IEC) / 24 - 14 AWG (UL)
- 250 V (IEC) / 300 V (UL)
- 24 A (IEC) / 16 A (UL)

Derating curve

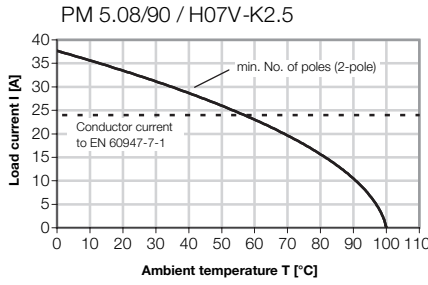

PM 5.08/90
PM 5.00/90

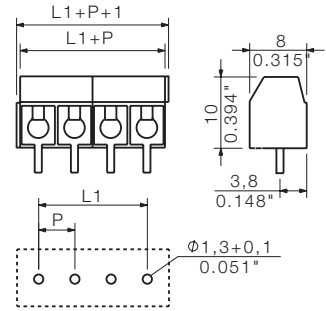

Technical data

Rated data to IEC 60664-1 / IEC 61984			
Clamping range, max.	mm ²	0.2...2.5	
Solid H05(07) V-U	mm ²	0.5...2.5	
Stranded H07 V-R	mm ²		
Flexible H05(07) V-K	mm ²	0.5...2.5	
Flexible with ferrule	mm ²	0.5...1.5	
Ferrule with plastic collar	mm ²	0.5...1.5	
Stripping length	mm	6	
Screwdriver blade	mm	0.6 x 3.5	
according to norm		DIN 5264	
Tightening torque range	Nm	0.4...0.45	
Rated current at ambient temperature			
	A	20°C	40°C
		24	24
Overvoltage category			
		III	III
Pollution severity			
		3	2
		2	2
Rated voltage	V	250	250
Rated impulse voltage	kV	4	4
		4	4
UL 1059 rated data - E60693			
		B	C
Rated voltage	V	300	300
Rated current	A	16	10
AWG conductor		24-14	
CSA C22.2 rated data - LR12400 B			
		B	C
Rated voltage	V	300	300
Rated current	A	16	10
AWG conductor		24-14	
Material data			
Type of insulating material		PA	
Flammability class acc. UL94		V-0	
Contact base material		Cu alloy	
Material of contact surface		tinned	
Information			

- Rated current related to rated cross-section and min. No. of poles.
- Wire end ferrule without plastic collar to DIN 46228 pt 1
- Wire end ferrule with plastic collar to DIN 46228 pt 4
- P on drg. = pitch
- Rated data refer only to the component itself. Clearance and creepage distances to other components are to be designed in accordance with the relevant application standards.

Ordering data

Solder pin length		3.5 mm	
Colour		black	
Pitch 5.08 mm			
Poles	L1 mm	(inch)	Qty.
2	5.08	(0.200)	500
3	10.16	(0.400)	500
Pitch 5.00 mm			
Poles	L1 mm	(inch)	Qty.
2	5.00	(0.197)	500
3	10.00	(0.394)	500

Accessories

Possible colors

Additional colours on request



Marking strips

See chapter accessories



Screwdriver

See chapter accessories
Order No. 9008390000



Tension clamp connection

LMZF 5.00

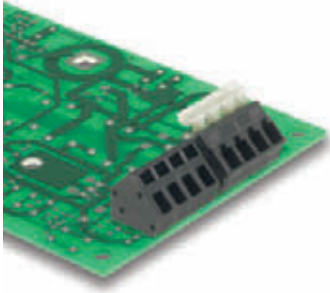

PCB terminal with tension clamp connection in 5.00 mm pitch. Conductor outlet direction 135°. Suitable for conductor cross-sections up to 2.5 mm². Also available with lever for opening the clamping point.

- 0.20 - 2.5 mm² (IEC) / 28 - 12 AWG (UL)
- 630 V (IEC) / 300 V (UL)
- 24 A (IEC) / 15 A (UL)

Derating curve

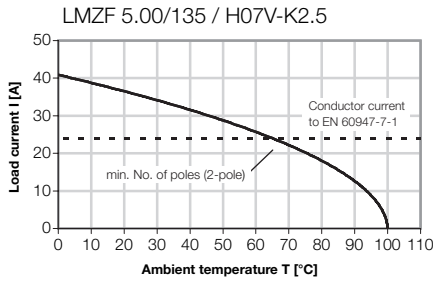

LMZF 5.00/135

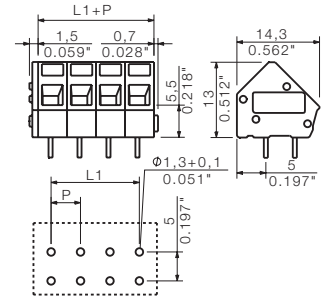

Technical data

Rated data to IEC 60664-1 / IEC 61984

Clamping range, max.	mm²	0.08...3.31	
Solid H05(07) V-U	mm²	0.5...2.5	
Stranded H07 V-R	mm²		
Flexible H05(07) V-K	mm²	0.5...2.5	
Flexible with ferrule	mm²	0.25...1.5	
Ferrule with plastic collar	mm²	0.25...1.5	
Stripping length	mm	6	
Screwdriver blade	mm	0.6 x 3.5	
according to norm		DIN 5264-A	
Tightening torque range	Nm		

Rated current

at ambient temperature		20°C	40°C
A		24	24

Overvoltage category

	III	III	II
--	-----	-----	----

Pollution severity

	3	2	2
--	---	---	---

Rated voltage	V	250	320	630
Rated impulse voltage	kV	4	4	4

UL 1059 rated data - E60693

	B	C	D	
Rated voltage	V	300	150	300
Rated current	A	15	15	10
AWG conductor		28-12		

CSA C22.2 rated data - LR12400 B

	B	C	D	
Rated voltage	V	300	150	300
Rated current	A	15	15	10
AWG conductor		28-12		

Material data

Type of insulating material	PA
Flammability class acc. UL94	V-0
Contact base material	Cu alloy
Material of contact surface	tinned

Information

- Rated current related to rated cross-section and min. No. of poles.
- Wire end ferrule without plastic collar to DIN 46228 pt 1
- Wire end ferrule with plastic collar to DIN 46228 pt 4
- The data given under CSA relates to a cUL approval - E60693
- P on drg. = pitch
- Rated data refer only to the component itself. Clearance and creepage distances to other components are to be designed in accordance with the relevant application standards.

Ordering data

Solder pin length	3.5 mm
Colour	black

Pitch 5.00 mm

Poles	L1 mm	(inch)	Qty.	Order No.	Order No.
2	5.00	(0.197)	100		1811840000
3	10.00	(0.394)	100		1811850000
4	15.00	(0.591)	100		1811860000
5	20.00	(0.787)	100		1811870000
6	25.00	(0.984)	100		1811880000
7	30.00	(1.181)	100		1811890000
8	35.00	(1.378)	100		1811900000
9	40.00	(1.575)	100		1811910000
10	45.00	(1.772)	100		1811920000
11	50.00	(1.969)	100		1811930000
12	55.00	(2.165)	100		1811940000

LMZFL 5.00/135

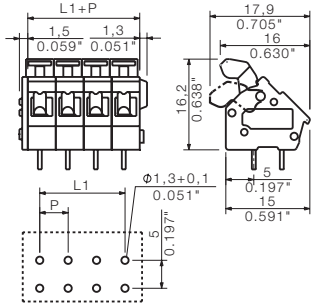

Accessories

Possible colors

Additional colours on request



Marking strips

See chapter accessories



Screwdriver

See chapter accessories
Order No. 9008330000



Ordering data

Solder pin length	3.5 mm
Colour	black

Pitch 5.00 mm

Poles	L1 mm	(inch)	Qty.	Order No.	Order No.
2	5.00	(0.197)	100		1811510000
3	10.00	(0.394)	100		1811520000
4	15.00	(0.591)	100		1811530000
5	20.00	(0.787)	100		1811540000
6	25.00	(0.984)	100		1811550000
7	30.00	(1.181)	100		1811560000
8	35.00	(1.378)	100		1811570000
9	40.00	(1.575)	100		1811580000
10	45.00	(1.772)	100		1811590000
11	50.00	(1.969)	100		1811600000
12	55.00	(2.165)	100		1811610000

Tension clamp connection

LMZF 5.08 multiple level

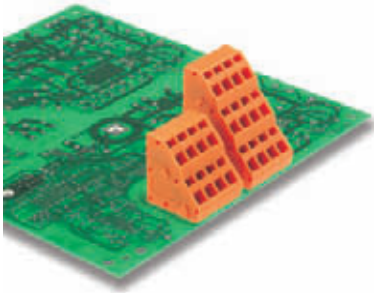

Multi level PCB terminal with clamping yoke connection in 5.08 mm pitch. Conductor outlet direction 135°. Suitable for conductor cross-sections up to 2.5 mm².

- 0.20 - 2.5 mm² (IEC) / 24 - 14 AWG (UL)
- 630 V (IEC) / 300 V (UL)
- 15 A (IEC) / 10 A (UL)

Technical data

Rated data to IEC 60664-1 / IEC 61984			
Clamping range, max.	mm ²	0.13...2.5	
Solid H05(07) V-U	mm ²	0.5...2.5	
Stranded H07 V-R	mm ²		
Flexible H05(07) V-K	mm ²	0.5...1.5	
Flexible with ferrule	mm ²	0.25...1.5	
Ferrule with plastic collar	mm ²	0.25...1.5	
Stripping length	mm	7.5	
Screwdriver blade	mm	0.6 x 3.5	
according to norm		DIN 5264-A	
Tightening torque range	Nm		
Rated current at ambient temperature			
	A	20°C	40°C
		15	13
Overvoltage category			
		III	III
Pollution severity			
		3	2
		2	2
Rated voltage	V	250	320
Rated impulse voltage	kV	4	4
		4	4
UL 1059 rated data - E60693			
		B	C
Rated voltage	V	300	300
Rated current	A	10	10
AWG conductor		24-14	
CSA C22.2 rated data - LR12400 B			
		B	C
Rated voltage	V	300	300
Rated current	A	10	10
AWG conductor		24-14	
Material data			
Type of insulating material		PA	
Flammability class acc. UL94		V-2	
Contact base material		Cu alloy	
Material of contact surface		tinned	
Information			

- Rated current related to rated cross-section and min. No. of poles.
- Wire end ferrule without plastic collar to DIN 46228 pt 1
- Wire end ferrule with plastic collar to DIN 46228 pt 4
- P on drg. = pitch
- Rated data refer only to the component itself. Clearance and creepage distances to other components are to be designed in accordance with the relevant application standards.

Derating curve

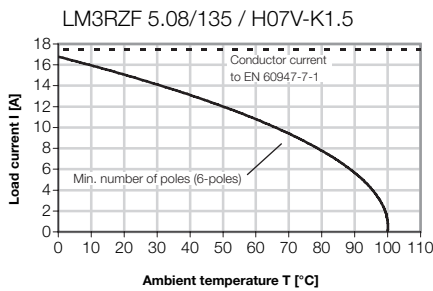
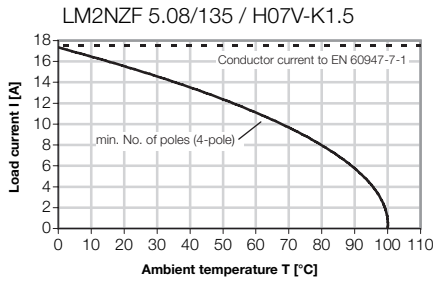

LM2NZF 5.08

2-row

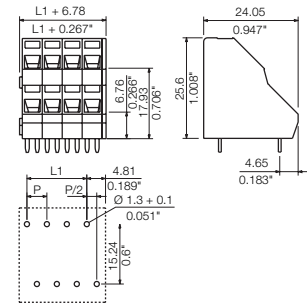

Ordering data

Solder pin length		3.5 mm	
Colour		orange	
Pitch 5.08 mm			
Poles	L1 mm (inch)	Qty.	Order No.
4	5.08 (0.200)	50	1764810000
6	10.16 (0.400)	50	1764820000
8	15.24 (0.600)	50	1764830000
10	20.32 (0.800)	50	1764840000
12	25.40 (1.000)	50	1764850000
14	30.48 (1.200)	20	1764860000
16	35.56 (1.400)	20	1764870000
18	40.64 (1.600)	20	1764880000
20	45.72 (1.800)	20	1758020000
22	50.80 (2.000)	20	1764890000
24	55.88 (2.200)	10	1764900000
26	60.96 (2.400)	10	1782500000
28	66.04 (2.600)	10	1782510000
30	71.12 (2.800)	10	1782520000
32	76.20 (3.000)	10	1782530000
34	81.28 (3.200)	10	1782540000
36	86.36 (3.400)	10	1782550000

LM3RZF 5.08

Triple level

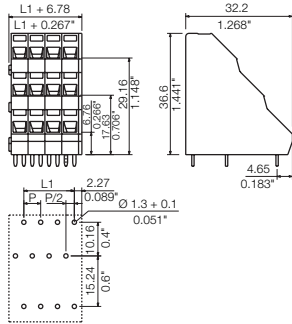

Accessories

Marking strips

See chapter accessories



Screwdriver

See chapter accessories
Order No. 9008330000



Ordering data

Solder pin length	3.5 mm
Colour	orange

Pitch 5.08 mm

Poles	L1 mm	(inch)	Qty.	Order No.	Order No.
6	5.08	(0.200)	50		1764910000
9	10.16	(0.400)	50		1764920000
12	15.24	(0.600)	50		1764930000
15	20.32	(0.800)	20		1764940000
18	25.40	(1.000)	20		1764950000
21	30.48	(1.200)	20		1758040000
24	35.56	(1.400)	10		1764960000
27	40.64	(1.600)	10		1764970000
30	45.72	(1.800)	10		1758030000
33	50.80	(2.000)	10		1764980000
36	55.88	(2.200)	10		1764990000
48	76.20	(3.000)	10		1758050000

Spade connection

PCF 5.00

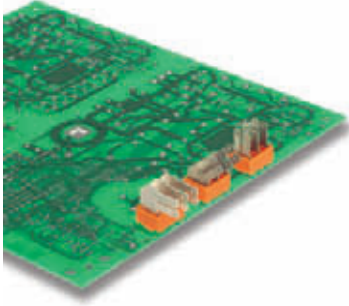

Spade connection in 90°, 135° and 180° conductor outlet direction for 6.3 and 2.8 mm spade crimps at 5.00 mm pitch

- 0.20 - 2.5 mm² (IEC) / 26 - 14 AWG (UL)
- 630 V (IEC) / 300 V (UL)
- 24 A (IEC) / 15 A (UL)

Technical data

Rated data to IEC 60664-1 / IEC 61984			
Clamping range, max.	mm ²	0.13...2.5	
Solid H05(07) V-U	mm ²	0.5...2.5	
Stranded H07 V-R	mm ²		
Flexible H05(07) V-K	mm ²	0.5...2.5	
Flexible with ferrule	mm ²		
Ferrule with plastic collar	mm ²		
Stripping length	mm		
Screwdriver blade according to norm	mm		
Tightening torque range	Nm		
Rated current at ambient temperature		20°C	40°C
	A	24	24
Overvoltage category		III	III
Pollution severity		3	2
Rated voltage	V	250	320
Rated impulse voltage	kV	4	4
UL 1059 rated data - E60693		B	C
Rated voltage	V	150	300
Rated current	A	15	10
AWG conductor		26-14	
CSA C22.2 rated data - LR12400 B		B	C
Rated voltage	V	150	300
Rated current	A	15	10
AWG conductor		26-14	
Material data			
Type of insulating material		PA	
Flammability class acc. UL94		V-2	
Contact base material		Cu alloy	
Material of contact surface		tinned	
Information			

- Rated current related to rated cross-section and min. No. of poles.
- Rated voltages with insulating sleeves IH 6.3 or IH 2.8
- P on drg. = pitch
- Rated data refer only to the component itself. Clearance and creepage distances to other components are to be designed in accordance with the relevant application standards.

Derating curve

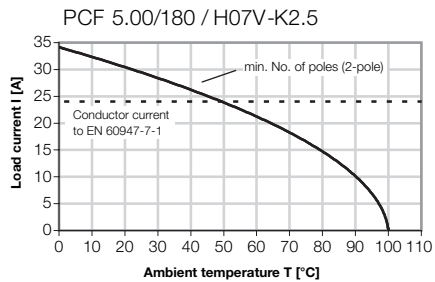
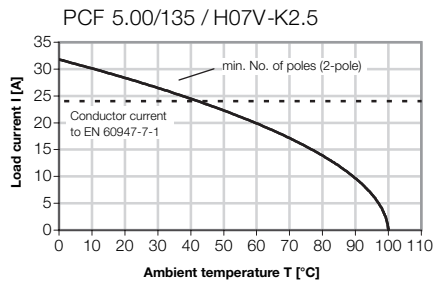
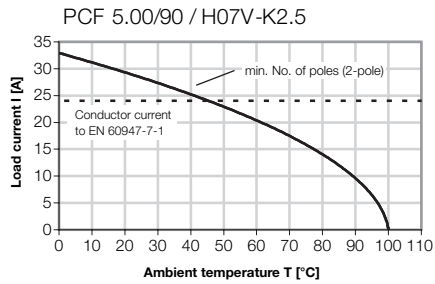

PCF 5.00/90

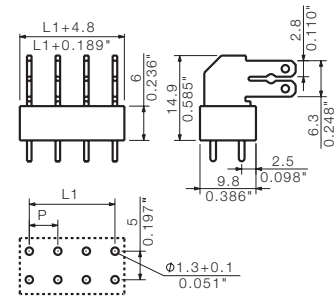

Ordering data

Solder pin length	3.5 mm
Colour	orange

Pitch 5.00 mm				
Poles	L1 mm (inch)	Qty.	Order No.	Order No.
2	5.00 (0.197)	100		9511410000
3	10.00 (0.394)	100		9511420000
4	15.00 (0.591)	100		9511430000
5	20.00 (0.787)	100		9511440000
6	25.00 (0.984)	100		9511450000
7	30.00 (1.181)	50		9511460000
8	35.00 (1.378)	50		9511470000
9	40.00 (1.575)	50		9511480000
10	45.00 (1.772)	50		9511490000
11	50.00 (1.969)	50		9511500000
12	55.00 (2.165)	50		9511510000
13	60.00 (2.362)	50		9511520000
14	65.00 (2.559)	50		9511530000
15	70.00 (2.756)	50		9511540000
16	75.00 (2.953)	50		9511550000
17	80.00 (3.150)	50		9511560000
18	85.00 (3.346)	50		9511570000
19	90.00 (3.543)	50		9511580000

PCF 5.00/135

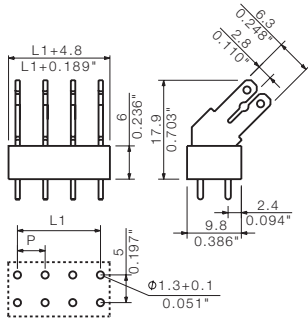

PCF 5.00/180

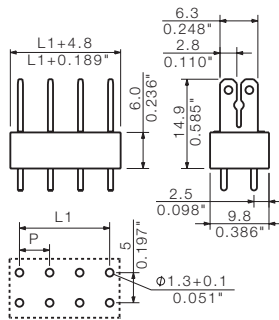

Ordering data

Solder pin length	3.5 mm
Colour	orange

Poles	L1 mm	(inch)	Qty.	Order No.	Order No.
2	5.00	(0.197)	100		9511790000
3	10.00	(0.394)	100		9511800000
4	15.00	(0.591)	100		9511810000
5	20.00	(0.787)	100		9511820000
6	25.00	(0.984)	100		9511830000
7	30.00	(1.181)	50		9511840000
8	35.00	(1.378)	50		9511850000
9	40.00	(1.575)	50		9511860000
10	45.00	(1.772)	50		9511870000
11	50.00	(1.969)	50		9511880000
12	55.00	(2.165)	50		9511890000
13	60.00	(2.362)	50		9511900000
14	65.00	(2.559)	50		9511910000
15	70.00	(2.756)	50		9511920000
16	75.00	(2.953)	50		9511930000
17	80.00	(3.150)	50		9511940000
18	85.00	(3.346)	50		9511950000
19	90.00	(3.543)	50		9511960000

Ordering data

Solder pin length	3.5 mm
Colour	orange

Poles	L1 mm	(inch)	Qty.	Order No.	Order No.
2	5.00	(0.197)	100		9500410000
3	10.00	(0.394)	100		9500420000
4	15.00	(0.591)	100		9500430000
5	20.00	(0.787)	100		9500440000
6	25.00	(0.984)	100		9500450000
7	30.00	(1.181)	50		9500460000
8	35.00	(1.378)	50		9500470000
9	40.00	(1.575)	50		9500480000
10	45.00	(1.772)	50		9500490000
11	50.00	(1.969)	50		9500510000
12	55.00	(2.165)	50		9500520000
13	60.00	(2.362)	50		9500530000
14	65.00	(2.559)	50		9500540000
15	70.00	(2.756)	50		9500550000
16	75.00	(2.953)	50		9500560000
17	80.00	(3.150)	50		9500570000
18	85.00	(3.346)	50		9500580000
19	90.00	(3.543)	50		9500590000

Pitch 5.00 mm

Poles	L1 mm	(inch)	Qty.	Order No.	Order No.
2	5.00	(0.197)	100		9511790000
3	10.00	(0.394)	100		9511800000
4	15.00	(0.591)	100		9511810000
5	20.00	(0.787)	100		9511820000
6	25.00	(0.984)	100		9511830000
7	30.00	(1.181)	50		9511840000
8	35.00	(1.378)	50		9511850000
9	40.00	(1.575)	50		9511860000
10	45.00	(1.772)	50		9511870000
11	50.00	(1.969)	50		9511880000
12	55.00	(2.165)	50		9511890000
13	60.00	(2.362)	50		9511900000
14	65.00	(2.559)	50		9511910000
15	70.00	(2.756)	50		9511920000
16	75.00	(2.953)	50		9511930000
17	80.00	(3.150)	50		9511940000
18	85.00	(3.346)	50		9511950000
19	90.00	(3.543)	50		9511960000

Pitch 5.00 mm

Poles	L1 mm	(inch)	Qty.	Order No.	Order No.
2	5.00	(0.197)	100		9500410000
3	10.00	(0.394)	100		9500420000
4	15.00	(0.591)	100		9500430000
5	20.00	(0.787)	100		9500440000
6	25.00	(0.984)	100		9500450000
7	30.00	(1.181)	50		9500460000
8	35.00	(1.378)	50		9500470000
9	40.00	(1.575)	50		9500480000
10	45.00	(1.772)	50		9500490000
11	50.00	(1.969)	50		9500510000
12	55.00	(2.165)	50		9500520000
13	60.00	(2.362)	50		9500530000
14	65.00	(2.559)	50		9500540000
15	70.00	(2.756)	50		9500550000
16	75.00	(2.953)	50		9500560000
17	80.00	(3.150)	50		9500570000
18	85.00	(3.346)	50		9500580000
19	90.00	(3.543)	50		9500590000

Accessories

Marking strips

See chapter accessories

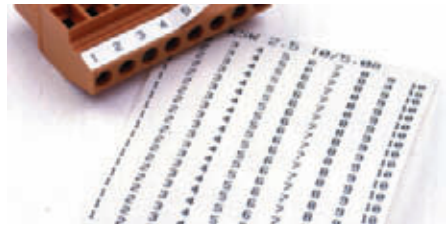

Crimping tool

See chapter accessories



Spade connection

PCF 7.50

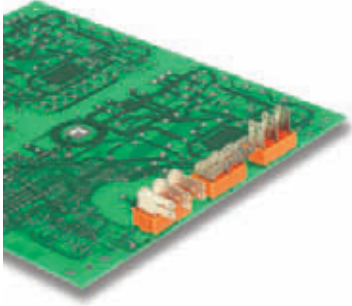

Spade connection in 90°, 135° and 180° conductor outlet direction for 6.3 and 2.8 mm spade crimps at 7.50 mm pitch

- 0.20 - 2.5 mm² (IEC) / 26 - 14 AWG (UL)
- 1000 V (IEC) / 300 V (UL)
- 24 A (IEC) / 15 A (UL)

Derating curve

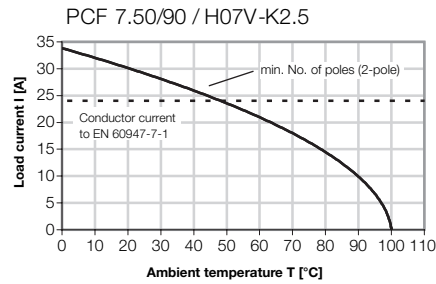

PCF 7.50/90

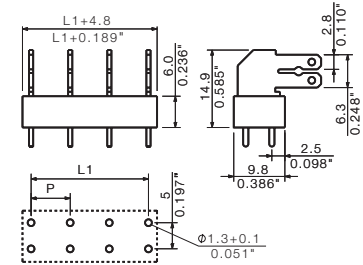

Technical data

Rated data to IEC 60664-1 / IEC 61984

Clamping range, max.	mm ²	0.13...2.5
Solid H05(07) V-U	mm ²	0.5...2.5
Stranded H07 V-R	mm ²	
Flexible H05(07) V-K	mm ²	0.5...2.5
Flexible with ferrule	mm ²	
Ferrule with plastic collar	mm ²	
Stripping length	mm	
Screwdriver blade according to norm	mm	
Tightening torque range	Nm	

Rated current at ambient temperature			
	20°C	40°C	
	A	24	24

Overvoltage category			
	III	III	II
Pollution severity			
	3	2	2

Rated voltage	V	500	690	1000
Rated impulse voltage	kV	6	6	6

UL 1059 rated data - E60693

UL 1059 rated data - E60693				
		B	C	D
Rated voltage	V	300	150	300
Rated current	A	15	15	10
AWG conductor		26-14		

CSA C22.2 rated data - LR12400 B

CSA C22.2 rated data - LR12400 B				
		B	C	D
Rated voltage	V	300	150	300
Rated current	A	15	15	10
AWG conductor		26-14		

Material data

Type of insulating material	PA
Flammability class acc. UL94	V-2
Contact base material	CuSn
Material of contact surface	tinned

Information

- Rated current related to rated cross-section and min. No. of poles.
- Rated voltages with insulating sleeves IH 6.3 or IH 2.8
- P on drg. = pitch
- Rated data refer only to the component itself. Clearance and creepage distances to other components are to be designed in accordance with the relevant application standards.

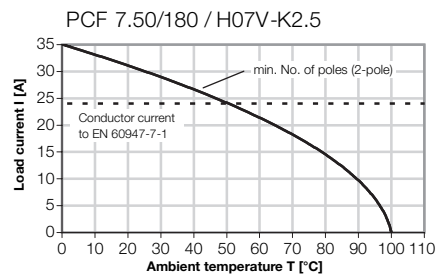
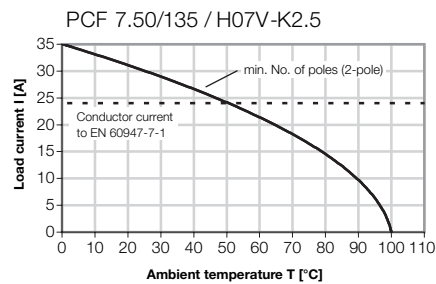

Ordering data

Solder pin length	3.5 mm
Colour	orange

Pitch 7.50 mm

Poles	L1 mm	(inch)	Qty.	Order No.	Order No.
2	7.50	(0.295)	100		9511590000
3	15.00	(0.591)	100		9511600000
4	22.50	(0.886)	100		9511610000
5	30.00	(1.181)	100		9511620000
6	37.50	(1.476)	100		9511630000
7	45.00	(1.772)	50		9511640000
8	52.50	(2.067)	50		9511650000
9	60.00	(2.362)	50		9512180000
10	67.50	(2.657)	50		9511660000
11	75.00	(2.953)	50		9511670000
12	82.50	(3.248)	50		9511680000
13	90.00	(3.543)	50		9511690000

PCF 7.50/135

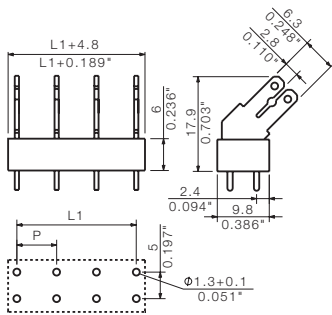

PCF 7.50/180

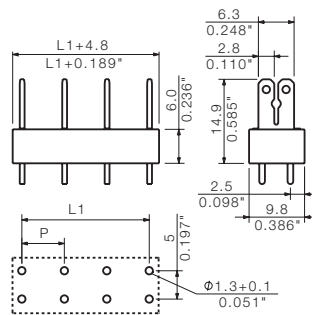

Accessories

Marking strips

See chapter accessories



Crimping tool

See chapter accessories



Ordering data

Solder pin length	3.5 mm
Colour	orange

Pitch 7.50 mm

Poles	L1 mm	(inch)	Qty.	Order No.	Order No.
2	7.50	(0.295)	100		9511970000
3	15.00	(0.591)	100		9511980000
4	22.50	(0.886)	100		9511990000
5	30.00	(1.181)	100		9512000000
6	37.50	(1.476)	100		9512010000
7	45.00	(1.772)	50		9512020000
8	52.50	(2.067)	50		9512030000
9	60.00	(2.362)	50		9512040000
10	67.50	(2.657)	50		9512050000
11	75.00	(2.953)	50		9512060000
12	82.50	(3.248)	50		9512070000
13	90.00	(3.543)	50		9512080000

Ordering data

Solder pin length	3.5 mm
Colour	orange

Pitch 7.50 mm

Poles	L1 mm	(inch)	Qty.	Order No.	Order No.
2	7.50	(0.295)	100		9500620000
3	15.00	(0.591)	50		9500630000
4	22.50	(0.886)	100		9500640000
5	30.00	(1.181)	100		9500650000
6	37.50	(1.476)	100		9500660000
7	45.00	(1.772)	50		9500670000
8	52.50	(2.067)	50		9500680000
9	60.00	(2.362)	50		9500690000
10	67.50	(2.657)	50		9500710000
11	75.00	(2.953)	50		9500720000
12	82.50	(3.248)	50		9500730000
13	90.00	(3.543)	50		9500740000

Spade connection

PCF 10.00

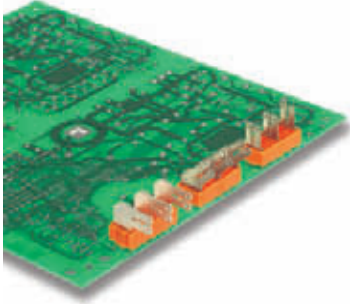

Spade connection in 90°, 135° and 180° conductor outlet direction for 6.3 and 2.8 mm spade crimps at 10 mm pitch

- 0.20 - 2.5 mm² (IEC) / 26 - 14 AWG (UL)
- 1000 V (IEC) / 300 V (UL)
- 24 A (IEC) / 15 A (UL)

Technical data

Rated data to IEC 60664-1 / IEC 61984

Clamping range, max.	mm ²	0.13...2.5	
Solid H05(07) V-U	mm ²	0.5...2.5	
Stranded H07 V-R	mm ²		
Flexible H05(07) V-K	mm ²	0.5...2.5	
Flexible with ferrule	mm ²		
Ferrule with plastic collar	mm ²		
Stripping length	mm		
Screwdriver blade	mm		
according to norm			
Tightening torque range	Nm		

Rated current at ambient temperature		20°C	40°C
	A	24	24

Overvoltage category		III	III	II
Pollution severity		3	2	2

Rated voltage	V	690	690	1000
Rated impulse voltage	kV	6	6	6

UL 1059 rated data - E60693

		B	C	D
Rated voltage	V	300	300	300
Rated current	A	15	15	10
AWG conductor		26-14		

@ CSA C22.2 rated data - LR12400 B

		B	C	D
Rated voltage	V	300	300	300
Rated current	A	15	15	10
AWG conductor		26-14		

Material data

Type of insulating material	PA
Flammability class acc. UL94	V-2
Contact base material	CuSn
Material of contact surface	tinned

Information

- Rated current related to rated cross-section and min. No. of poles.
- Rated voltages with insulating sleeves IH 6.3 or IH 2.8
- P on drg. = pitch
- Rated data refer only to the component itself. Clearance and creepage distances to other components are to be designed in accordance with the relevant application standards.

Derating curve

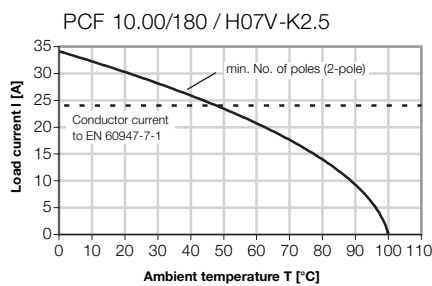
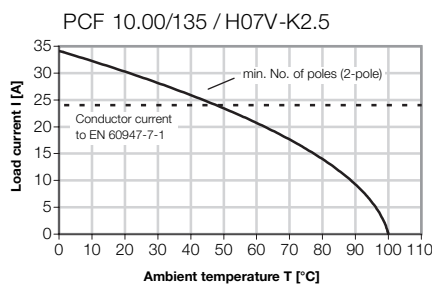
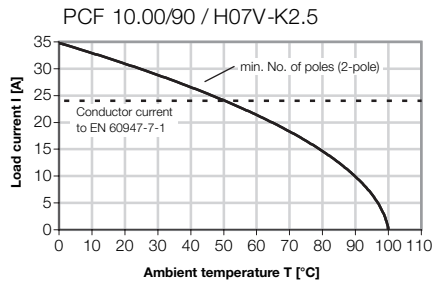

PCF 10.00/90

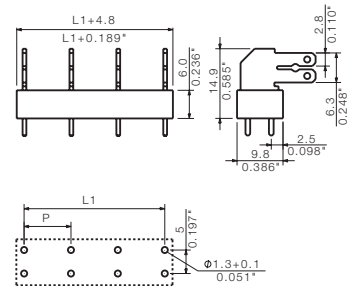

Ordering data

Solder pin length	3.5 mm
Colour	orange

Pitch 10 mm				
Poles	L1 mm	(inch)	Qty.	Order No.
2	10.00	(0.394)	100	951170000
3	20.00	(0.787)	100	951171000
4	30.00	(1.181)	100	951172000
5	40.00	(1.575)	100	951173000
6	50.00	(1.969)	100	951174000
7	60.00	(2.362)	50	951175000
8	70.00	(2.756)	50	951176000
9	80.00	(3.150)	50	951177000
10	90.00	(3.543)	50	951178000

PCF 10.00/135

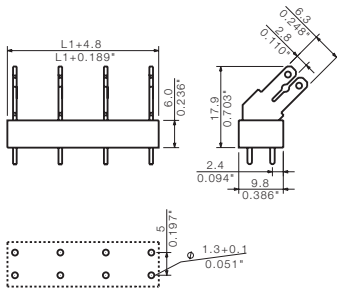

PCF 10.00/180

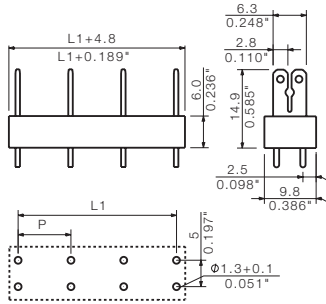

Accessories

Marking strips

See chapter accessories



Crimping tool

See chapter accessories



Ordering data

Solder pin length	3.5 mm
Colour	orange

Pitch 10 mm

Poles	L1 mm	(inch)	Qty.	Order No.	Order No.
2	10.00	(0.394)	100		9512090000
3	20.00	(0.787)	100		9512100000
4	30.00	(1.181)	100		9512110000
5	40.00	(1.575)	100		9512120000
6	50.00	(1.969)	100		9512130000
7	60.00	(2.362)	50		9512140000
8	70.00	(2.756)	50		9512150000
9	80.00	(3.150)	50		9512160000
10	90.00	(3.543)	50		9512170000

Ordering data

Solder pin length	3.5 mm
Colour	orange

Pitch 10 mm

Poles	L1 mm	(inch)	Qty.	Order No.	Order No.
2	10.00	(0.394)	100		9500750000
3	20.00	(0.787)	100		9500760000
4	30.00	(1.181)	100		9500770000
5	40.00	(1.575)	100		9500780000
6	50.00	(1.969)	50		9500790000
7	60.00	(2.362)	50		9500810000
8	70.00	(2.756)	50		9500820000
9	80.00	(3.150)	50		9500830000
10	90.00	(3.543)	50		9500840000

THR PCB Terminals with clamping yoke connection

LM-THR 3.5



Through Hole Reflow (THR), high-temperature-resistant, small, compact PCB terminal with proven clamping yoke connection at 3.5 mm pitch, conductor outlet direction 90°, suitable for conductor cross-sections up to 1.5 mm².

- 0.20 - 1.5 mm² (IEC) / 28 - 14 AWG (UL)
- 320 V (IEC) / 300 V (UL)
- 16 A (IEC) / 10 A (UL)

Derating curve

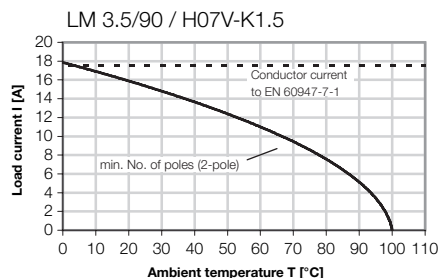

LM-THR 3.5/90

Reflow-compatible PCB terminal

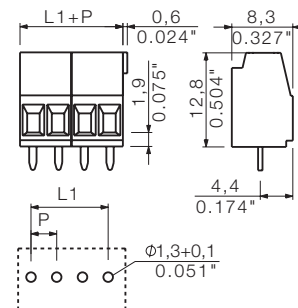

Technical data

Rated data to IEC 60664-1 / IEC 61984

Clamping range, max.	mm ²	0.08...2.08
Solid H05(07) V-U	mm ²	0.5...1.5
Stranded H07 V-R	mm ²	
Flexible H05(07) V-K	mm ²	0.5...1.5
Flexible with ferrule	mm ²	
Ferrule with plastic collar	mm ²	0.5...0.75
Stripping length	mm	5
Screwdriver blade	mm	0.4 x 2.5
according to norm		DIN 5264
Tightening torque range	Nm	0.2...0.25

Rated current

at ambient temperature		20°C	40°C
A		16	14

Overvoltage category

		III	III	II
--	--	-----	-----	----

Pollution severity		3	2	2
--------------------	--	---	---	---

Rated voltage	V	125	160	320
---------------	---	-----	-----	-----

Rated impulse voltage	kV	2.5	2.5	2.5
-----------------------	----	-----	-----	-----

UL 1059 rated data - E60693

Rated voltage	V	300	300
---------------	---	-----	-----

Rated current	A	10	10
---------------	---	----	----

AWG conductor		28-14	
---------------	--	-------	--

@ CSA C22.2 rated data - LR12400 B

Rated voltage	V	300	300
---------------	---	-----	-----

Rated current	A	10	10
---------------	---	----	----

AWG conductor		28-14	
---------------	--	-------	--

Material data

Type of insulating material		PA
-----------------------------	--	----

Flammability class acc. UL94		V-2
------------------------------	--	-----

Contact base material		Cu alloy
-----------------------	--	----------

Material of contact surface		tinned
-----------------------------	--	--------

Information

- Rated current related to rated cross-section and min. No. of poles.
- Max. O.D. of conductor: 2.9 mm
- Wire end ferrule with plastic collar to DIN 46228 pt 4
- P on drg. = pitch
- Rated data refer only to the component itself. Clearance and creepage distances to other components are to be designed in accordance with the relevant application standards.

Ordering data

Solder pin length	3.2 mm
Colour	black

Pitch 3.50 mm					
Poles	L1 mm	(inch)	Qty.	Order No.	Order No.
2	3.50	(0.138)	100		1789130000
3	7.00	(0.276)	100		1789140000

Accessories

Marking strips

See chapter accessories

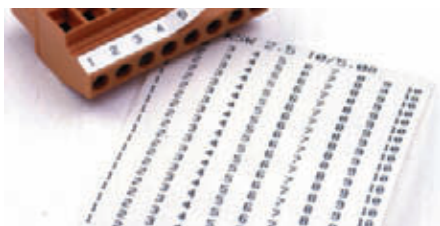

Screwdriver

See chapter accessories
Order No. 9008370000



THR PCB Terminals with clamping yoke connection

LP-THR 5.08



Through Hole Reflow (THR), high-temperature-resistant PCB terminal with proven clamping yoke connection at 5.08 mm pitch, conductor outlet direction 90°, suitable for conductor cross-sections up to 6.0 mm².

- 0.20 - 6.0mm² (IEC) / 26 - 12 AWG (UL)
- 500 V (IEC) / 300 V (UL)
- 32 A (IEC) / 20 A (UL)

Derating curve

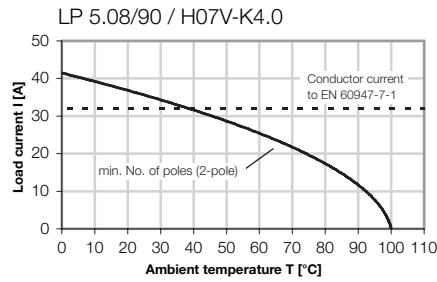

LP-THR 5.08/90

Reflow-compatible PCB terminal

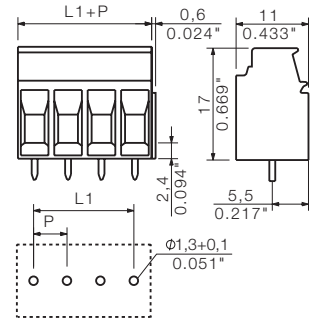

Technical data

Rated data to IEC 60664-1 / IEC 61984

Clamping range, max.	mm²	0.13...6
Solid H05(07) V-U	mm²	0.5...6
Stranded H07 V-R	mm²	
Flexible H05(07) V-K	mm²	0.5...4
Flexible with ferrule	mm²	0.5...2.5
Ferrule with plastic collar	mm²	0.5...2.5
Stripping length	mm	6
Screwdriver blade	mm	0.6 x 3.5
according to norm		DIN 5264
Tightening torque range	Nm	0.5...0.6

Rated current at ambient temperature

	A	20°C	40°C
		32	32

Overvoltage category

	III	III	II
--	-----	-----	----

Pollution severity

	3	2	2
--	---	---	---

Rated voltage	V	250	250	500
Rated impulse voltage	kV	4	4	4

UL 1059 rated data - E60693

	B	C	D
--	---	---	---

Rated voltage	V	300	300
Rated current	A	20	10
AWG conductor		26-12	

CSA C22.2 rated data - LR12400 B

	B	C	D
--	---	---	---

Rated voltage	V	300	300
Rated current	A	20	10
AWG conductor		26-12	

Material data

Type of insulating material	PA
Flammability class acc. UL94	V-2
Contact base material	Cu alloy
Material of contact surface	tinned

Information

- Rated current related to rated cross-section and min. No. of poles.
- Wire end ferrule without plastic collar to DIN 46228 pt 1
- Wire end ferrule with plastic collar to DIN 46228 pt 4
- P on drg. = pitch
- Rated data refer only to the component itself. Clearance and creepage distances to other components are to be designed in accordance with the relevant application standards.

Ordering data

Solder pin length	3.2 mm
Colour	black

Pitch 5.08 mm

Poles	L1 mm	(inch)	Qty.	Order No.	Order No.
2	5.08	(0.200)	100		1789150000
3	10.16	(0.400)	100		1789160000

Accessories

Marking strips

See chapter accessories



Screwdriver

See chapter accessories
Order No. 9008390000



THR PCB Terminals with push-in connection

LSF-SMT 3.81/90
LSF-SMT 3.50/90

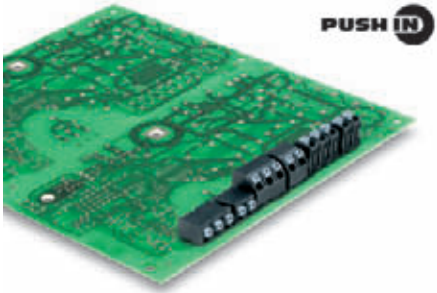

PCB terminal for fully automatic assembly in reflow soldering (SMT), with Push-In conductor connection system. Conductor inserted and slider operated in same direction (TOP). Packaged in tube or as tape on reel. Pin lengths optimised at 1.5 mm or 3.5 mm. Conductor outlet direction 90°.

- 0.20 - 1.5 mm² (IEC) / 24 - 16 AWG (UL)
- 320 V (IEC) / 300 V (UL)
- 17.5 A (IEC) / 10 A (UL)

Derating curve

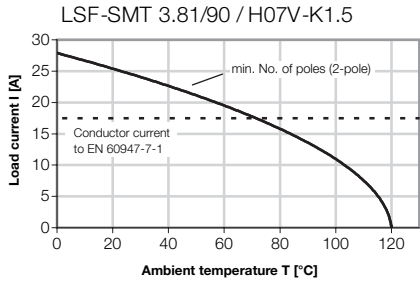

LSF-SMT 3.81/90
LSF-SMT 3.50/90

Reflow-compatible PCB terminal

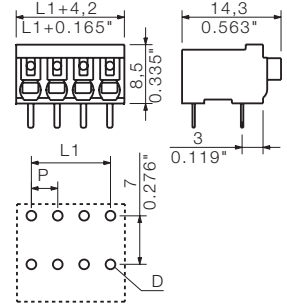

Technical data

Rated data to IEC 60664-1 / IEC 61984			
Clamping range, max.	mm ²	0.13...1.5	
Solid H05(07) V-U	mm ²	0.2...1.5	
Stranded H07 V-R	mm ²		
Flexible H05(07) V-K	mm ²	0.2...1.5	
Flexible with ferrule	mm ²	0.25...1.5	
Ferrule with plastic collar	mm ²		
Stripping length	mm	8	
Screwdriver blade according to norm	mm		
Tightening torque range	Nm		
Rated current at ambient temperature			
	A	20°C	40°C
		17.5	17.5
Overvoltage category			
		III	III
Pollution severity			
		3	2
Rated voltage	V	160	160
Rated impulse voltage	kV	2.5	2.5
UL 1059 rated data - E60693			
		B	C
Rated voltage	V	300	300
Rated current	A	10	10
AWG conductor		24-16	
CSA C22.2 rated data - LR12400 B			
		B	C
Rated voltage	V	300	300
Rated current	A	10	10
AWG conductor		24-16	
Material data			
Type of insulating material		LCP GF	
Flammability class acc. UL94		V-0	
Contact base material		Cu alloy	
Material of contact surface		tinned	

- Information**
- Additional colours on request
 - Rated current related to rated cross-section and min. No. of poles.
 - Wire end ferrule without plastic collar to DIN 46228 pt 1
 - The data given under CSA relates to a cUL approval - E60693
 - P on drg. = pitch
 - Hole diameter D = 1.1+0.1mm
 - Operating force of slider max. 40 N
 - Rated data refer only to the component itself. Clearance and creepage distances to other components are to be designed in accordance with the relevant application standards.

Ordering data

Solder pin length	1.5 mm	3.5 mm		
Colour	black	black		
Pitch 3.81 mm				
Poles	L1 mm (inch)	Qty.	Order No.	Order No.
2	3.81 (0.150)	100	1869360000	1824620000
3	7.62 (0.300)	100	1869370000	1824630000
4	11.43 (0.450)	100	1869380000	1824640000
5	15.24 (0.600)	50	1869390000	1824650000
6	19.05 (0.750)	50	1869400000	1824660000
7	22.86 (0.900)	50	1869410000	1824690000
8	26.67 (1.050)	50	1869420000	1824700000
9	30.48 (1.200)	50	1869430000	1824710000
10	34.29 (1.350)	50	1869440000	1824720000
11	38.10 (1.500)	50	1869450000	1824730000
12	41.91 (1.650)	50	1869460000	1825300000
13	45.72 (1.800)	50	1869470000	1871200000
14	49.53 (1.950)	50	1869480000	1871210000
15	53.34 (2.100)	50	1869500000	1871220000
16	57.15 (2.250)	50	1869510000	1871230000
17	60.96 (2.400)	20	1869520000	1871240000
18	64.77 (2.550)	20	1869530000	1871250000
19	68.58 (2.700)	20	1869540000	1871260000
20	72.39 (2.850)	20	1869550000	1871270000
21	76.20 (3.000)	20	1869560000	1871280000
22	80.01 (3.150)	20	1869570000	1871290000
23	83.82 (3.300)	20	1869580000	1871300000
24	87.63 (3.450)	20	1869590000	1871310000
Pitch 3.50 mm				
Poles	L1 mm (inch)	Qty.	Order No.	Order No.
2	3.50 (0.138)	100	1870500000	1824420000
3	7.00 (0.276)	100	1870530000	1824430000
4	10.50 (0.413)	100	1870550000	1824440000
5	14.00 (0.551)	50	1870580000	1824450000
6	17.50 (0.689)	50	1870590000	1824460000
7	21.00 (0.827)	50	1871020000	1824470000
8	24.50 (0.965)	50	1871030000	1824480000
9	28.00 (1.102)	50	1871040000	1824490000
10	31.50 (1.240)	50	1871050000	1824500000
11	35.00 (1.378)	50	1871060000	1824510000
12	38.50 (1.516)	50	1871070000	1824520000
13	42.00 (1.654)	50	1871080000	1870380000
14	45.50 (1.791)	50	1871090000	1870390000
15	49.00 (1.929)	50	1871100000	1870400000
16	52.50 (2.067)	50	1871110000	1870410000
17	56.00 (2.205)	20	1871120000	1870420000
18	59.50 (2.343)	20	1871130000	1870430000
19	63.00 (2.480)	20	1871140000	1870440000
20	66.50 (2.618)	20	1871150000	1870450000
21	70.00 (2.756)	20	1871160000	1870460000
22	73.50 (2.894)	20	1871170000	1870470000
23	77.00 (3.031)	20	1871180000	1870480000
24	80.50 (3.169)	20	1871190000	1870490000

LSF-SMT 3.81/90 Tape
LSF-SMT 3.50/90 Tape

Reflow-compatible PCB terminal

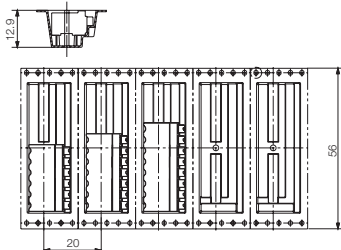

Accessories

Possible colors

Additional colours on request



Marking strips

See chapter accessories

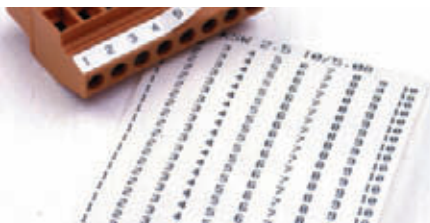

Ordering data

Solder pin length	1.5 mm	3.5 mm
Colour	black	black

Pitch 3.81 mm

Poles	L1 mm	(inch)	Qty.	Order No.	Order No.
2	3.81	(0.150)	200	1875170000	1875920000
3	7.62	(0.300)	200	1875230000	1875930000
4	11.43	(0.450)	200	1875240000	1875940000
5	15.24	(0.600)	200	1875250000	1875950000
6	19.05	(0.750)	265	1875260000	1875960000
7	22.86	(0.900)	200	1875270000	1875970000
8	26.67	(1.050)	200	1875280000	1875980000
9	30.48	(1.200)	200	1875290000	1875990000
10	34.29	(1.350)	200	1875300000	1876000000
11	38.10	(1.500)	200	1875310000	1876010000

Pitch 3.50 mm

Poles	L1 mm	(inch)	Qty.	Order No.	Order No.
2	3.50	(0.138)	200	1874690000	1874990000
3	7.00	(0.276)	200	1874710000	1875030000
4	10.50	(0.413)	200	1874730000	1875050000
5	14.00	(0.551)	200	1874740000	1875070000
6	17.50	(0.689)	200	1874810000	1875080000
7	21.00	(0.827)	200	1874840000	1875100000
8	24.50	(0.965)	200	1874890000	1875110000
9	28.00	(1.102)	200	1874900000	1875120000
10	31.50	(1.240)	200	1874930000	1875130000
11	35.00	(1.378)	200	1874940000	1875140000
12	38.50	(1.516)	200	1874970000	1875160000

THR PCB Terminals with push-in connection

LSF-SMT 3.81/135
LSF-SMT 3.50/135

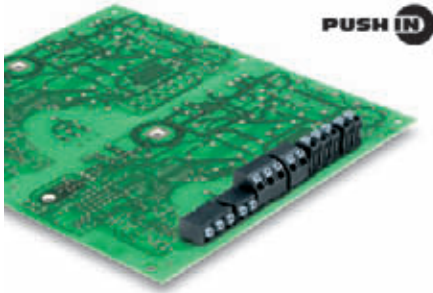

Derating curve

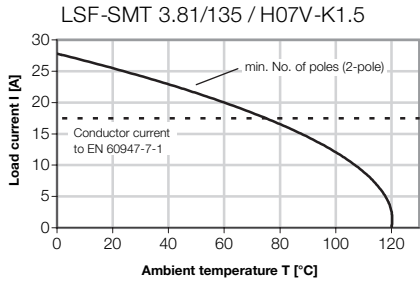

PCB terminal for fully automatic assembly in reflow soldering (SMT), with Push-In conductor connection system. Conductor inserted and slider operated in same direction (TOP). Packaged in tube or as tape on reel. Pin lengths optimised at 1.5 mm or 3.5 mm. Conductor outlet direction 135°.

- 0.20 - 1.5 mm² (IEC) / 24 - 16 AWG (UL)
- 320 V (IEC) / 300 V (UL)
- 17.5 A (IEC) / 10 A (UL)

Technical data

Rated data to IEC 60664-1 / IEC 61984			
Clamping range, max.	mm ²	0.13...1.5	
Solid H05(07) V-U	mm ²	0.2...1.5	
Stranded H07 V-R	mm ²		
Flexible H05(07) V-K	mm ²	0.2...1.5	
Flexible with ferrule	mm ²	0.25...1.5	
Ferrule with plastic collar	mm ²		
Stripping length	mm	8	
Screwdriver blade according to norm	mm		
Tightening torque range	Nm		
Rated current at ambient temperature			
	A	20°C 17.5	40°C 17.5
Overvoltage category			
		III	II
Pollution severity			
		3	2
Rated voltage	V	160	320
Rated impulse voltage	kV	2.5	2.5
UL 1059 rated data - E60693			
		B	C
Rated voltage	V	300	300
Rated current	A	10	10
AWG conductor		24-16	
CSA C22.2 rated data - LR12400 B			
		B	C
Rated voltage	V	300	300
Rated current	A	10	10
AWG conductor		24-16	
Material data			
Type of insulating material		LCP GF	
Flammability class acc. UL94		V-0	
Contact base material		Cu alloy	
Material of contact surface		tinned	

- Information**
- Additional colours on request
 - Rated current related to rated cross-section and min. No. of poles.
 - Wire end ferrule without plastic collar to DIN 46228 pt 1
 - The data given under CSA relates to a cUL approval - E60693
 - P on drg. = pitch
 - Hole diameter D = 1.1+0.1mm
 - Operating force of slider max. 40 N
 - Rated data refer only to the component itself. Clearance and creepage distances to other components are to be designed in accordance with the relevant application standards.

LSF-SMT 3.81/135
LSF-SMT 3.50/135

Reflow-compatible PCB terminal

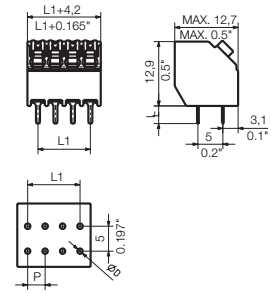

Ordering data

Solder pin length	1.5 mm	3.5 mm		
Colour	black	black		
Pitch 3.81 mm				
Poles	L1 mm (inch)	Qty.	Order No.	Order No.
2	3.81 (0.150)	100	1885410000	1885880000
3	7.62 (0.300)	100	1885420000	1885890000
4	11.43 (0.450)	100	1885430000	1885900000
5	15.24 (0.600)	50	1885440000	1885910000
6	19.05 (0.750)	50	1885450000	1885920000
7	22.86 (0.900)	50	1885460000	1885930000
8	26.67 (1.050)	50	1885470000	1885940000
9	30.48 (1.200)	50	1885480000	1885950000
10	34.29 (1.350)	50	1885490000	1885960000
11	38.10 (1.500)	50	1885510000	1885970000
12	41.91 (1.650)	50	1885520000	1885980000
13	45.72 (1.800)	50	1885530000	1885990000
14	49.53 (1.950)	50	1885540000	1886000000
15	53.34 (2.100)	50	1885550000	1886010000
16	57.15 (2.250)	50	1885560000	1886020000
17	60.96 (2.400)	20	1885570000	1886030000
18	64.77 (2.550)	20	1885580000	1886040000
19	68.58 (2.700)	20	1885590000	1886050000
20	72.39 (2.850)	20	1885600000	1886060000
21	76.20 (3.000)	20	1885610000	1886070000
22	80.01 (3.150)	20	1885620000	1886080000
23	83.82 (3.300)	20	1885630000	1886090000
24	87.63 (3.450)	20	1885640000	1886100000
Pitch 3.50 mm				
Poles	L1 mm (inch)	Qty.	Order No.	Order No.
2	3.50 (0.138)	100	1885180000	1885650000
3	7.00 (0.276)	100	1885190000	1885660000
4	10.50 (0.413)	100	1885200000	1885670000
5	14.00 (0.551)	50	1885210000	1885680000
6	17.50 (0.689)	50	1885220000	1885690000
7	21.00 (0.827)	50	1885230000	1885700000
8	24.50 (0.965)	50	1885240000	1885710000
9	28.00 (1.102)	50	1885250000	1885720000
10	31.50 (1.240)	50	1885260000	1885730000
11	35.00 (1.378)	50	1885270000	1885740000
12	38.50 (1.516)	50	1885280000	1885750000
13	42.00 (1.654)	50	1885290000	1885760000
14	45.50 (1.791)	50	1885300000	1885770000
15	49.00 (1.929)	50	1885310000	1885780000
16	52.50 (2.067)	50	1885320000	1885790000
17	56.00 (2.205)	20	1885330000	1885800000
18	59.50 (2.343)	20	1885340000	1885810000
19	63.00 (2.480)	20	1885350000	1885820000
20	66.50 (2.618)	20	1885360000	1885830000
21	70.00 (2.756)	20	1885370000	1885840000
22	73.50 (2.894)	20	1885380000	1885850000
23	77.00 (3.031)	20	1885390000	1885860000
24	80.50 (3.169)	20	1885400000	1885870000

LSF-SMT 3.81/135 Tape
LSF-SMT 3.50/135 Tape

Reflow-compatible PCB terminal

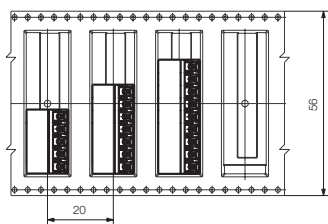

Accessories

Possible colors

Additional colours on request



Marking strips

See chapter accessories

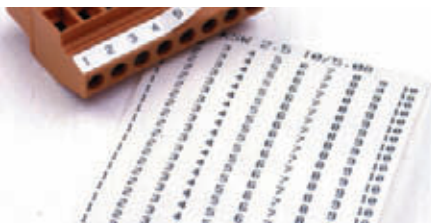

Ordering data

Solder pin length	1.5 mm	3.5 mm
Colour	black	black

Pitch 3.81 mm

Poles	L1 mm	(inch)	Qty.	Order No.	Order No.
2	3.81	(0.150)	175	1888450000	1888320000
3	7.62	(0.300)	175	1888460000	1888330000
4	11.43	(0.450)	175	1888470000	1888340000
5	15.24	(0.600)	175	1888480000	1888380000
6	19.05	(0.750)	175	1888490000	1888390000
7	22.86	(0.900)	175	1888500000	1888400000
8	26.67	(1.050)	175	1888510000	1888410000
9	30.48	(1.200)	175	1888520000	1888420000
10	34.29	(1.350)	175	1888530000	1888430000
11	38.10	(1.500)	175	1888540000	1888440000

Pitch 3.50 mm

Poles	L1 mm	(inch)	Qty.	Order No.	Order No.
2	3.50	(0.138)	175	1887550000	1887340000
3	7.00	(0.276)	175	1887560000	1887350000
4	10.50	(0.413)	175	1887580000	1887360000
5	14.00	(0.551)	175	1887630000	1887460000
6	17.50	(0.689)	175	1887640000	1887470000
7	21.00	(0.827)	175	1887650000	1887480000
8	24.50	(0.965)	175	1887660000	1887490000
9	28.00	(1.102)	175	1887670000	1887500000
10	31.50	(1.240)	175	1887680000	1887510000
11	35.00	(1.378)	175	1887690000	1887520000
12	38.50	(1.516)	175	1887700000	1887530000

THR PCB Terminals with push-in connection

LSF-SMT 3.81/180
LSF-SMT 3.50/180

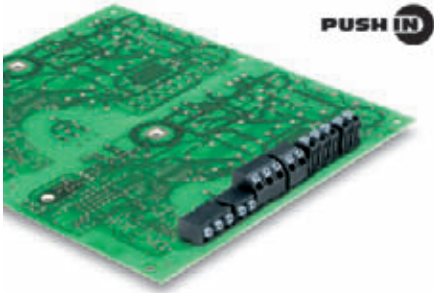

Derating curve

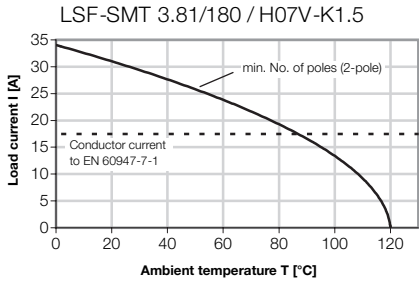

PCB terminal for fully automatic assembly in reflow soldering (SMT), with Push-In conductor connection system. Conductor inserted and slider operated in same direction (TOP). Packaged in tube or as tape on reel. Pin lengths optimised at 1.5 mm or 3.5 mm. Conductor outlet direction 180°.

- 0.20 - 1.5 mm² (IEC) / 24 - 16 AWG (UL)
- 320 V (IEC) / 300 V (UL)
- 17.5 A (IEC) / 10 A (UL)

Technical data

Rated data to IEC 60664-1 / IEC 61984			
Clamping range, max.	mm ²	0.13...1.5	
Solid H05(07) V-U	mm ²	0.2...1.5	
Stranded H07 V-R	mm ²		
Flexible H05(07) V-K	mm ²	0.2...1.5	
Flexible with ferrule	mm ²	0.25...1.5	
Ferrule with plastic collar	mm ²		
Stripping length	mm	8	
Screwdriver blade according to norm	mm		
Tightening torque range	Nm		
Rated current at ambient temperature			
	A	20°C	40°C
		17.5	17.5
Overvoltage category			
		III	III
Pollution severity			
		3	2
Rated voltage	V	160	160
Rated impulse voltage	kV	2.5	2.5
UL 1059 rated data - E60693			
		B	C
Rated voltage	V	300	300
Rated current	A	10	10
AWG conductor		24-16	
CSA C22.2 rated data - LR12400 B			
		B	C
Rated voltage	V	300	300
Rated current	A	10	10
AWG conductor		24-16	
Material data			
Type of insulating material		LCP GF	
Flammability class acc. UL94		V-0	
Contact base material		Cu alloy	
Material of contact surface		tinned	

Information

- Additional colours on request
- Rated current related to rated cross-section and min. No. of poles.
- Wire end ferrule without plastic collar to DIN 46228 pt 1
- The data given under CSA relates to a cUL approval - E60693
- P on drg. = pitch
- Hole diameter D = 1.1+0.1mm
- Operating force of slider max. 40 N
- Rated data refer only to the component itself. Clearance and creepage distances to other components are to be designed in accordance with the relevant application standards.

LSF-SMT 3.81/180
LSF-SMT 3.50/180

Reflow-compatible PCB terminal

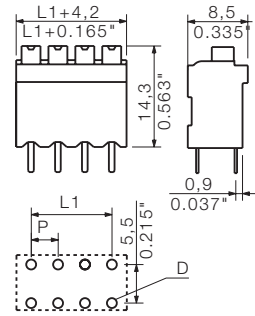

Ordering data

Solder pin length	1.5 mm	3.5 mm		
Colour	black	black		
Pitch 3.81 mm				
Poles	L1 mm (inch)	Qty.	Order No.	Order No.
2	3.81 (0.150)	100	1869890000	1825790000
3	7.62 (0.300)	100	1869900000	1825800000
4	11.43 (0.450)	100	1869910000	1825810000
5	15.24 (0.600)	50	1869920000	1825820000
6	19.05 (0.750)	50	1869930000	1825830000
7	22.86 (0.900)	50	1869940000	1825840000
8	26.67 (1.050)	50	1869950000	1825850000
9	30.48 (1.200)	50	1869960000	1825870000
10	34.29 (1.350)	50	1869970000	1825880000
11	38.10 (1.500)	50	1870000000	1825890000
12	41.91 (1.650)	50	1870010000	1825920000
13	45.72 (1.800)	50	1870020000	1870900000
14	49.53 (1.950)	50	1870030000	1870910000
15	53.34 (2.100)	50	1870040000	1870920000
16	57.15 (2.250)	50	1870050000	1870930000
17	60.96 (2.400)	20	1870060000	1870940000
18	64.77 (2.550)	20	1870070000	1870950000
19	68.58 (2.700)	20	1870080000	1870960000
20	72.39 (2.850)	20	1870090000	1870970000
21	76.20 (3.000)	20	1870100000	1870980000
22	80.01 (3.150)	20	1870110000	1870990000
23	83.82 (3.300)	20	1870120000	1871000000
24	87.63 (3.450)	20	1870130000	1871010000
Pitch 3.50 mm				
Poles	L1 mm (inch)	Qty.	Order No.	Order No.
2	3.50 (0.138)	100	1870640000	1825640000
3	7.00 (0.276)	100	1870650000	1825650000
4	10.50 (0.413)	100	1870660000	1825660000
5	14.00 (0.551)	50	1870670000	1825670000
6	17.50 (0.689)	50	1870680000	1825680000
7	21.00 (0.827)	50	1870690000	1825690000
8	24.50 (0.965)	50	1870700000	1825700000
9	28.00 (1.102)	50	1870710000	1825710000
10	31.50 (1.240)	50	1870720000	1825720000
11	35.00 (1.378)	50	1870730000	1825730000
12	38.50 (1.516)	50	1870740000	1825740000
13	42.00 (1.654)	50	1870750000	1870350000
14	45.50 (1.791)	50	1870760000	1870360000
15	49.00 (1.929)	50	1870770000	1870370000
16	52.50 (2.067)	50	1870790000	1870510000
17	56.00 (2.205)	20	1870800000	1870520000
18	59.50 (2.343)	20	1870830000	1870540000
19	63.00 (2.480)	20	1870840000	1870560000
20	66.50 (2.618)	20	1870850000	1870570000
21	70.00 (2.756)	20	1870860000	1870600000
22	73.50 (2.894)	20	1870870000	1870610000
23	77.00 (3.031)	20	1870880000	1870620000
24	80.50 (3.169)	20	1870890000	1870630000

LSF-SMT 3.81/180 Tape
LSF-SMT 3.50/180 Tape

Reflow-compatible PCB terminal

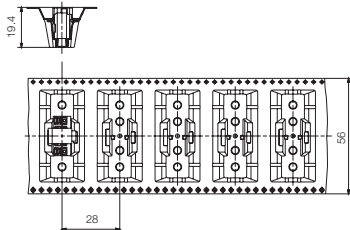

Accessories

Possible colors

Additional colours on request



Marking strips

See chapter accessories

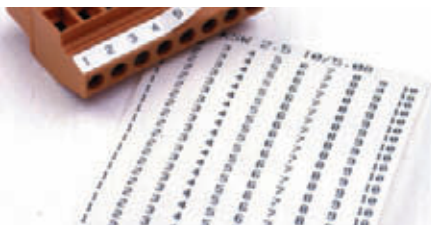

Ordering data

Solder pin length	1.5 mm	3.5 mm
Colour	black	black

Pitch 3.81 mm

Poles	L1 mm	(inch)	Qty.	Order No.	Order No.
2	3.81	(0.150)	100	1875320000	1875550000
3	7.62	(0.300)	100	1875330000	1875570000
4	11.43	(0.450)	100	1875340000	1875590000
5	15.24	(0.600)	100	1875350000	1875650000
6	19.05	(0.750)	100	1875360000	1875670000
7	22.86	(0.900)	100	1875370000	1875680000
8	26.67	(1.050)	100	1875380000	1875710000
9	30.48	(1.200)	100	1875390000	1875730000
10	34.29	(1.350)	100	1875400000	1875760000
11	38.10	(1.500)	100	1875410000	1875810000

Pitch 3.50 mm

Poles	L1 mm	(inch)	Qty.	Order No.	Order No.
2	3.50	(0.138)	100	1874490000	1874510000
3	7.00	(0.276)	100	1874300000	1874520000
4	10.50	(0.413)	100	1874280000	1874540000
5	14.00	(0.551)	100	1874310000	1874560000
6	17.50	(0.689)	100	1874320000	1874590000
7	21.00	(0.827)	100	1874340000	1874600000
8	24.50	(0.965)	100	1874350000	1874610000
9	28.00	(1.102)	100	1874370000	1874620000
10	31.50	(1.240)	100	1874380000	1874640000
11	35.00	(1.378)	100	1874400000	1874660000
12	38.50	(1.516)	100	1874420000	1874680000

THR PCB Terminals with push-in connection

LSF-SMT 5.08/90 LSF-SMT 5.00/90

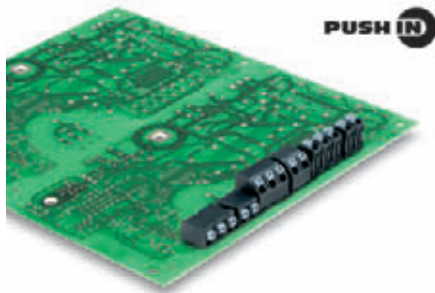

Derating curve

PCB terminal for fully automatic assembly in reflow soldering (SMT), with Push-In conductor connection system. Conductor inserted and slider operated in same direction (TOP). Packaged in tube or as tape on reel. Pin lengths optimised at 1.5 mm or 3.5 mm. Conductor outlet direction 90°.

- 0.20 - 1.5 mm² (IEC) / 24 - 16 AWG (UL)
- 500 V (IEC) / 300 V (UL)
- 17.5 A (IEC) / 10 A (UL)

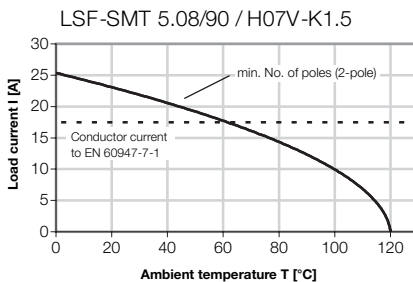

Technical data

Rated data to IEC 60664-1 / IEC 61984			
Clamping range, max.	mm ²	0.13...1.5	
Solid H05(07) V-U	mm ²	0.2...1.5	
Stranded H07 V-R	mm ²		
Flexible H05(07) V-K	mm ²	0.2...1.5	
Flexible with ferrule	mm ²	0.25...1.5	
Ferrule with plastic collar	mm ²		
Stripping length	mm	8	
Screwdriver blade according to norm	mm		
Tightening torque range	Nm		
Rated current at ambient temperature			
	A	20°C	40°C
		17.5	17.5
Overvoltage category			
		III	III
Pollution severity			
		3	2
		2	2
Rated voltage	V	250	320
Rated impulse voltage	kV	4	4
		4	4
UL 1059 rated data - E60693			
		B	C
Rated voltage	V	300	300
Rated current	A	10	10
AWG conductor		24-16	
CSA C22.2 rated data - LR12400 B			
		B	C
Rated voltage	V	300	300
Rated current	A	10	10
AWG conductor		24-16	
Material data			
Type of insulating material		LCP GF	
Flammability class acc. UL94		V-0	
Contact base material		Cu alloy	
Material of contact surface		tinned	
Information			

- Rated current related to rated cross-section and min. No. of poles.
- Wire end ferrule without plastic collar to DIN 46228 pt 1
- The data given under CSA relates to a cUL approval - E60693
- P on drg. = pitch
- Hole diameter D = 1.1+0.1mm
- Operating force of slider max. 40 N
- Rated data refer only to the component itself. Clearance and creepage distances to other components are to be designed in accordance with the relevant application standards.

LSF-SMT 5.08/90 LSF-SMT 5.00/90

Reflow-compatible PCB terminal

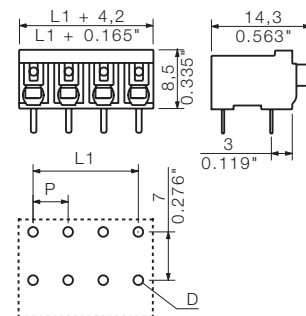

Ordering data

Solder pin length	1.5 mm	3.5 mm	
Colour	black	black	
Pitch 5.08 mm			
Poles	L1 mm (inch)	Qty.	Order No.
2	5.08 (0.200)	100	1869670000
3	10.16 (0.400)	100	1869680000
4	15.24 (0.600)	100	1869690000
5	20.32 (0.800)	50	1869700000
6	25.40 (1.000)	50	1869710000
7	30.48 (1.200)	50	1869720000
8	35.56 (1.400)	50	1869730000

Pitch 5.00 mm			
Poles	L1 mm (inch)	Qty.	Order No.
2	5.00 (0.197)	100	1869600000
3	10.00 (0.394)	100	1869610000
4	15.00 (0.591)	100	1869620000
5	20.00 (0.787)	50	1869630000
6	25.00 (0.984)	50	1869640000
7	30.00 (1.181)	50	1869650000
8	35.00 (1.378)	50	1869660000

LSF-SMT 5.08/90 Tape
LSF-SMT 5.00/90 Tape

Reflow-compatible PCB terminal

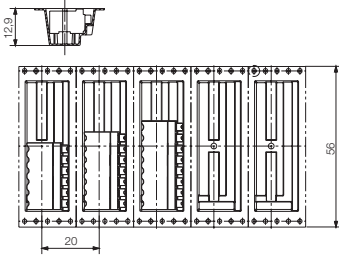

Accessories

Possible colors

Additional colours on request



Marking strips

See chapter accessories



Ordering data

Solder pin length	1.5 mm	3.5 mm
Colour	black	black

Pitch 5.08 mm

Poles	L1 mm	(inch)	Qty.	Order No.	Order No.
2	5.08	(0.200)	200	1876480000	1876470000
3	10.16	(0.400)	200	1876440000	1876420000
4	15.24	(0.600)	200	1878520000	1876310000
5	20.32	(0.800)	200	1876210000	1876190000
6	25.40	(1.000)	200	1876150000	1876120000
7	30.48	(1.200)	200	1875720000	1875690000
8	35.56	(1.400)	200	1875520000	1875510000

Pitch 5.00 mm

Poles	L1 mm	(inch)	Qty.	Order No.	Order No.
2	5.00	(0.197)	200	1876240000	1876430000
3	10.00	(0.394)	200	1876260000	1876510000
4	15.00	(0.591)	200	1876270000	1876530000
5	20.00	(0.787)	200	1876280000	1876550000
6	25.00	(0.984)	200	1876300000	1876560000
7	30.00	(1.181)	200	1876330000	1876540000
8	35.00	(1.378)	200	1876350000	1876520000

THR PCB Terminals with push-in connection

LSF-SMT 5.08/135
LSF-SMT 5.00/135

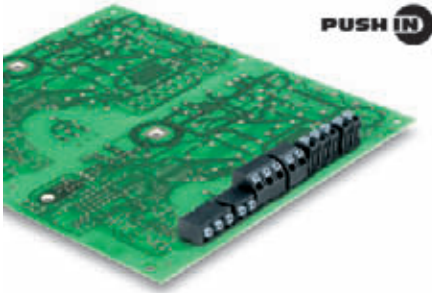

PCB terminal for fully automatic assembly in reflow soldering (SMT), with Push-In conductor connection system. Conductor inserted and slider operated in same direction (TOP). Packaged in tube or as tape on reel. Pin lengths optimised at 1.5 mm or 3.5 mm. Conductor outlet direction 135°.

- 0.20 - 1.5 mm² (IEC) / 24 - 16 AWG (UL)
- 500 V (IEC) / 300 V (UL)
- 17.5 A (IEC) / 10 A (UL)

Derating curve

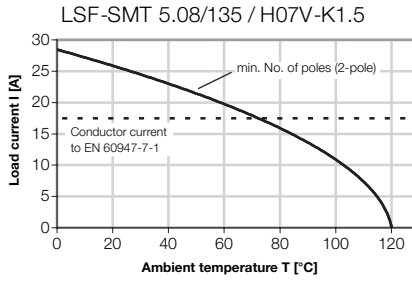

LSF-SMT 5.08/135
LSF-SMT 5.00/135

Reflow-compatible PCB terminal

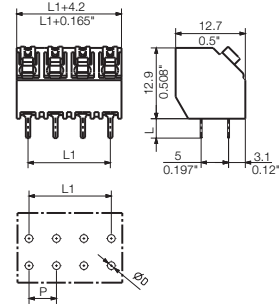

Technical data

Rated data to IEC 60664-1 / IEC 61984			
Clamping range, max.	mm ²	0.13...1.5	
Solid H05(07) V-U	mm ²	0.2...1.5	
Stranded H07 V-R	mm ²		
Flexible H05(07) V-K	mm ²	0.2...1.5	
Flexible with ferrule	mm ²	0.25...1.5	
Ferrule with plastic collar	mm ²		
Stripping length	mm	8	
Screwdriver blade according to norm	mm		
Tightening torque range	Nm		
Rated current at ambient temperature			
	A	20°C	40°C
		17.5	17.5
Overvoltage category			
		III	III II
Pollution severity			
		3	2 2
Rated voltage	V	250	320 500
Rated impulse voltage	kV	4	4 4
UL 1059 rated data - E60693			
		B	C D
Rated voltage	V	300	300
Rated current	A	10	10
AWG conductor		24-16	
CSA C22.2 rated data - LR12400 B			
		B	C D
Rated voltage	V	300	300
Rated current	A	10	10
AWG conductor		24-16	
Material data			
Type of insulating material		LCP GF	
Flammability class acc. UL94		V-0	
Contact base material		Cu alloy	
Material of contact surface		tinned	

- Information**
- Rated current related to rated cross-section and min. No. of poles.
 - Wire end ferrule without plastic collar to DIN 46228 pt 1
 - The data given under CSA relates to a cUL approval - E60693
 - P on drg. = pitch
 - Hole diameter D = 1.1+0.1mm
 - Operating force of slider max. 40 N
 - Rated data refer only to the component itself. Clearance and creepage distances to other components are to be designed in accordance with the relevant application standards.

Ordering data

Solder pin length	1.5 mm	3.5 mm		
Colour	black	black		
Pitch 5.08 mm				
Poles	L1 mm (inch)	Qty.	Order No.	Order No.
2	5.08 (0.200)	100	1884730000	1885020000
3	10.16 (0.400)	100	1884740000	1885030000
4	15.24 (0.600)	100	1884750000	1885040000
5	20.32 (0.800)	50	1884760000	1885050000
6	25.40 (1.000)	50	1884770000	1885060000
7	30.48 (1.200)	50	1884780000	1885070000
8	35.56 (1.400)	50	1884790000	1885080000
9	40.64 (1.600)	50	1884800000	1885090000
10	45.72 (1.800)	50	1884810000	1885100000
11	50.80 (2.000)	50	1884820000	1885110000
12	55.88 (2.200)	50	1884830000	1885120000
13	60.96 (2.400)	50	1884840000	1885130000
14	66.04 (2.600)	50	1884850000	1885140000
15	71.12 (2.800)	50	1884860000	1885150000
16	76.20 (3.000)	50	1884870000	1885160000

Pitch 5.00 mm				
Poles	L1 mm (inch)	Qty.	Order No.	Order No.
2	5.00 (0.197)	100	1884530000	1884340000
3	10.00 (0.394)	100	1884540000	1884370000
4	15.00 (0.591)	100	1884550000	1884380000
5	20.00 (0.787)	50	1884560000	1884390000
6	25.00 (0.984)	50	1884570000	1884400000
7	30.00 (1.181)	50	1884580000	1884410000
8	35.00 (1.378)	50	1884590000	1884420000
9	40.00 (1.575)	50	1884600000	1884430000
10	45.00 (1.772)	50	1884660000	1884440000
11	50.00 (1.969)	50	1884670000	1884450000
12	55.00 (2.165)	50	1884680000	1884460000
13	60.00 (2.362)	50	1884690000	1884470000
14	65.00 (2.559)	50	1884700000	1884500000
15	70.00 (2.756)	50	1884710000	1884510000
16	75.00 (2.953)	50	1884720000	1884520000

LSF-SMT 5.08/135 Tape
LSF-SMT 5.00/135 Tape

Reflow-compatible PCB terminal

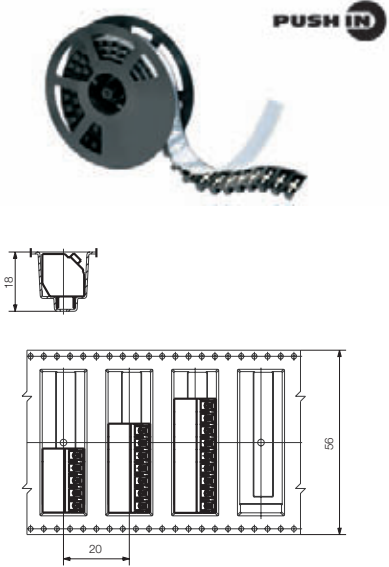

Accessories

Possible colors

Additional colours on request



Marking strips

See chapter accessories

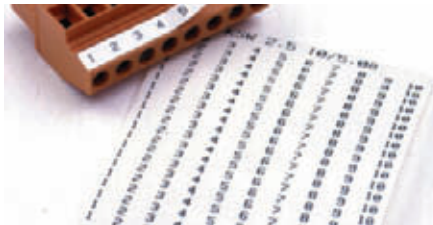

Ordering data

Solder pin length	1.5 mm	3.5 mm
Colour	black	black

Pitch 5.08 mm

Poles	L	l	mm	(inch)	Qty.	Order No.	Order No.
2	5.08	0.200	175	1888710000	1888780000		
3	10.16	0.400	175	1888720000	1888790000		
4	15.24	0.600	175	1888730000	1888810000		
5	20.32	0.800	175	1888740000	1888830000		
6	25.40	1.000	175	1888750000	1888840000		
7	30.48	1.200	175	1888760000	1888870000		
8	35.56	1.400	175	1888770000	1888880000		

Pitch 5.00 mm

Poles	L	l	mm	(inch)	Qty.	Order No.	Order No.
2	5.00	0.197	175	1888570000	1888640000		
3	10.00	0.394	175	1888580000	1888650000		
4	15.00	0.591	175	1888590000	1888660000		
5	20.00	0.787	175	1888600000	1888670000		
6	25.00	0.984	175	1888610000	1888680000		
7	30.00	1.181	175	1888620000	1888690000		
8	35.00	1.378	175	1888630000	1888700000		

THR PCB Terminals with push-in connection

LSF-SMT 5.08/180
LSF-SMT 5.00/180

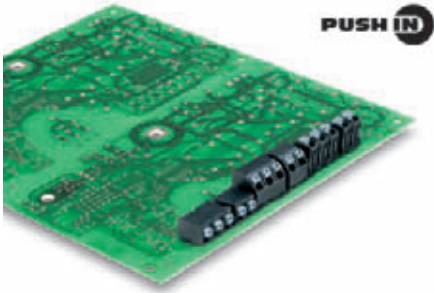

PCB terminal for fully automatic assembly in reflow soldering (SMT), with Push-In conductor connection system. Conductor inserted and slider operated in same direction (TOP). Packaged in tube or as tape on reel. Pin lengths optimised at 1.5 mm or 3.5 mm. Conductor outlet direction 180°.

- 0.20 - 1.5 mm² (IEC) / 24 - 16 AWG (UL)
- 500 V (IEC) / 300 V (UL)
- 17.5 A (IEC) / 10 A (UL)

Derating curve

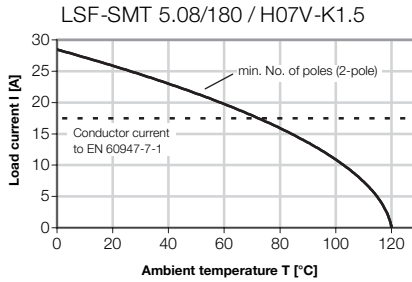

LSF-SMT 5.08/180
LSF-SMT 5.00/180

Reflow-compatible PCB terminal

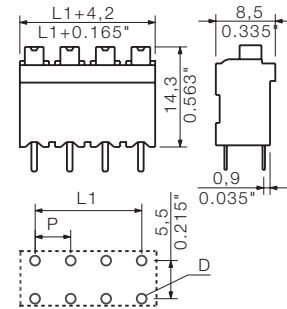

Technical data

Rated data to IEC 60664-1 / IEC 61984

Clamping range, max.	mm ²	0.13...1.5	
Solid H05(07) V-U	mm ²	0.2...1.5	
Stranded H07 V-R	mm ²		
Flexible H05(07) V-K	mm ²	0.2...1.5	
Flexible with ferrule	mm ²	0.25...1.5	
Ferrule with plastic collar	mm ²		
Stripping length	mm	8	
Screwdriver blade according to norm	mm		
Tightening torque range	Nm		

Rated current at ambient temperature

	A	20°C	40°C
		17.5	17.5

Overvoltage category

		III	III	II
--	--	-----	-----	----

Pollution severity

		3	2	2
--	--	---	---	---

Rated voltage	V	250	320	500
Rated impulse voltage	kV	4	4	4

UL 1059 rated data - E60693

		B	C	D
Rated voltage	V	300	300	
Rated current	A	10	10	
AWG conductor		24-16		

CSA C22.2 rated data - LR12400 B

		B	C	D
Rated voltage	V	300	300	
Rated current	A	10	10	
AWG conductor		24-16		

Material data

Type of insulating material	LCP GF
Flammability class acc. UL94	V-0
Contact base material	Cu alloy
Material of contact surface	tinned

Information

- Rated current related to rated cross-section and min. No. of poles.
- Wire end ferrule without plastic collar to DIN 46228 pt 1
- The data given under CSA relates to a cUL approval - E60693
- P on drg. = pitch
- Hole diameter D = 1.1+0.1mm
- Operating force of slider max. 40 N
- Rated data refer only to the component itself. Clearance and creepage distances to other components are to be designed in accordance with the relevant application standards.

Ordering data

Solder pin length	1.5 mm	3.5 mm
Colour	black	black

Pitch 5.08 mm

Poles	L1 mm	(inch)	Qty.	Order No.	Order No.
2	5.08	(0.200)	100	1870210000	1826040000
3	10.16	(0.394)	100	1870220000	1826060000
4	15.24	(0.600)	100	1870230000	1826070000
5	20.32	(0.800)	50	1870240000	1826080000
6	25.40	(1.000)	50	1870250000	1826100000
7	30.48	(1.200)	50	1870260000	1826110000
8	35.56	(1.400)	50	1870270000	1826120000

Pitch 5.00 mm

Poles	L1 mm	(inch)	Qty.	Order No.	Order No.
2	5.00	(0.197)	100	1870140000	1825960000
3	10.00	(0.394)	100	1870150000	1825970000
4	15.00	(0.591)	100	1870160000	1825980000
5	20.00	(0.787)	50	1870170000	1825990000
6	25.00	(0.984)	50	1870180000	1826000000
7	30.00	(1.181)	50	1870190000	1826010000
8	35.00	(1.378)	50	1870200000	1826020000

LSF-SMT 5.08/180 Tape
LSF-SMT 5.00/180 Tape

Reflow-compatible PCB terminal

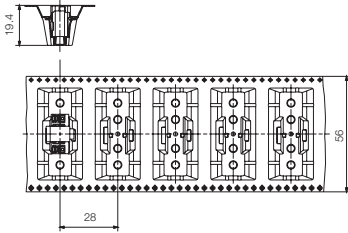

Accessories

Possible colors

Additional colours on request



Marking strips

See chapter accessories

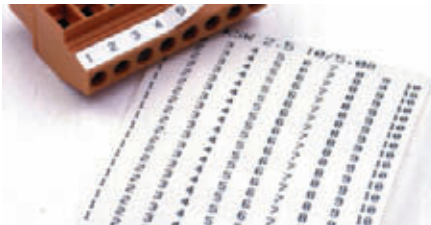

Ordering data

Solder pin length	1.5 mm	3.5 mm
Colour	black	black

Pitch 5.08 mm

Poles	L1 mm	(inch)	Qty.	Order No.	Order No.
2	5.08	(0.200)	100	1876500000	1876490000
3	10.16	(0.400)	100	1876460000	1876450000
4	15.24	(0.600)	100	1876410000	1876360000
5	20.32	(0.800)	100	1876290000	1876250000
6	25.40	(1.000)	100	1876180000	1876170000
7	30.48	(1.200)	100	1876100000	1875750000
8	35.56	(1.400)	100	1875610000	1875580000

Pitch 5.00 mm

Poles	L1 mm	(inch)	Qty.	Order No.	Order No.
2	5.00	(0.197)	100	1876020000	1876110000
3	10.00	(0.394)	100	1876030000	1876130000
4	15.00	(0.591)	100	1876050000	1876140000
5	20.00	(0.787)	175	1876060000	1876160000
6	25.00	(0.984)	100	1876070000	1876200000
7	30.00	(1.181)	100	1876080000	1876220000
8	35.00	(1.378)	100	1876090000	1876230000

THR PCB Terminals with push-in connection

LSF-SMT 7.62/90
LSF-SMT 7.50/90

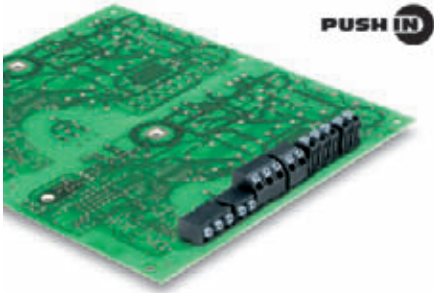

Derating curve

PCB terminal for fully automatic assembly in reflow soldering (SMT), with Push-In conductor connection system. Conductor inserted and slider operated in same direction (TOP). Packaged in tube or as tape on reel. Pin lengths optimised at 1.5 mm or 3.5 mm. Conductor outlet direction 90°.

- 0.20 - 1.5 mm² (IEC) / 24 - 16 AWG (UL)
- 800 V (IEC) / 300 V (UL)
- 17.5 A (IEC) / 10 A (UL)

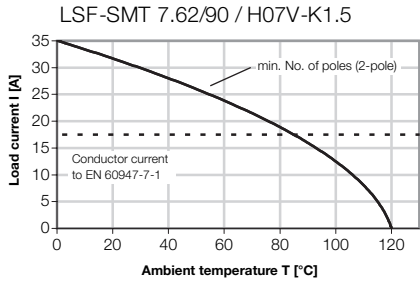

LSF-SMT 7.62/90
LSF-SMT 7.50/90

Reflow-compatible PCB terminal

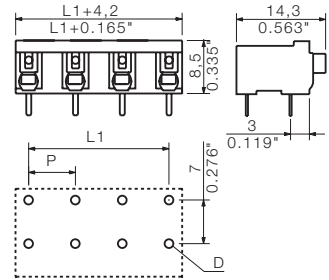

Technical data

Rated data to IEC 60664-1 / IEC 61984

Clamping range, max.	mm ²	0.13...1.5	
Solid H05(07) V-U	mm ²	0.2...1.5	
Stranded H07 V-R	mm ²		
Flexible H05(07) V-K	mm ²	0.2...1.5	
Flexible with ferrule	mm ²	0.25...1.5	
Ferrule with plastic collar	mm ²		
Stripping length	mm	8	
Screwdriver blade	mm		
according to norm			
Tightening torque range	Nm		

Rated current at ambient temperature

	A	20°C	40°C
		17.5	17.5

Overvoltage category

		III	III	II
--	--	-----	-----	----

Pollution severity

		3	2	2
--	--	---	---	---

Rated voltage	V	500	630	800
Rated impulse voltage	kV	6	6	6

UL 1059 rated data - E60693

		B	C	D
--	--	---	---	---

Rated voltage	V	300	150	300
Rated current	A	10	10	10
AWG conductor		24-16		

CSA C22.2 rated data - LR12400 B

		B	C	D
--	--	---	---	---

Rated voltage	V	300	150	300
Rated current	A	10	10	10
AWG conductor		24-16		

Material data

Type of insulating material	LCP GF
Flammability class acc. UL94	V-0
Contact base material	Cu alloy
Material of contact surface	tinned

Information

- Rated current related to rated cross-section and min. No. of poles.
- Wire end ferrule without plastic collar to DIN 46228 pt 1
- The data given under CSA relates to a cUL approval - E60693
- P on drg. = pitch
- Hole diameter D = 1.1+0.1mm
- Operating force of slider max. 40 N
- Rated data refer only to the component itself. Clearance and creepage distances to other components are to be designed in accordance with the relevant application standards.

Ordering data

Solder pin length	1.5 mm	3.5 mm
Colour	black	black

Pitch 7.62 mm

Poles	L1 mm	(inch)	Qty.	Order No.	Order No.
2	7.62	(0.300)	100	1869260000	1824950000
3	15.24	(0.600)	100	1869270000	1824960000
4	22.86	(0.900)	100	1869280000	1824970000
5	30.48	(1.200)	50	1869290000	1824980000
6	38.10	(1.500)	50	1869300000	1824990000
7	45.72	(1.800)	50	1869310000	1825000000
8	53.34	(2.100)	50	1869320000	1825010000

Pitch 7.50 mm

Poles	L1 mm	(inch)	Qty.	Order No.	Order No.
2	7.50	(0.295)	100	1869740000	1824880000
3	15.00	(0.591)	100	1869750000	1824890000
4	22.50	(0.886)	100	1869760000	1824900000
5	30.00	(1.181)	50	1869770000	1824910000
6	37.50	(1.476)	50	1869780000	1824920000
7	45.00	(1.772)	50	1869790000	1824930000
8	52.50	(2.067)	50	1869800000	1824940000

LSF-SMT 7.62/90 Tape
LSF-SMT 7.50/90 Tape

Reflow-compatible PCB terminal

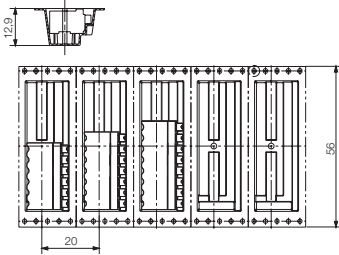

Accessories

Possible colors

Additional colours on request



Marking strips

See chapter accessories



Ordering data

Solder pin length	1.5 mm	3.5 mm
Colour	black	black

Pitch 7.62 mm

Poles	L1 mm	(inch)	Qty.	Order No.	Order No.
2	7.62	(0.300)	200	1874700000	1874670000
3	15.24	(0.600)	200	1874570000	1874550000
4	22.86	(0.900)	200	1874480000	1874470000
5	30.48	(1.200)	200	1874430000	1874410000
6	38.10	(1.500)	200	1874330000	1874290000

Pitch 7.50 mm

Poles	L1 mm	(inch)	Qty.	Order No.	Order No.
2	7.50	(0.295)	200	1875480000	1875470000
3	15.00	(0.591)	200	1875440000	1875430000
4	22.50	(0.886)	200	1875040000	1875020000
5	30.00	(1.181)	200	1874980000	1874960000
6	37.50	(1.476)	200	1874910000	1874880000

THR PCB Terminals with push-in connection

LSF-SMT 7.62/135
LSF-SMT 7.50/135

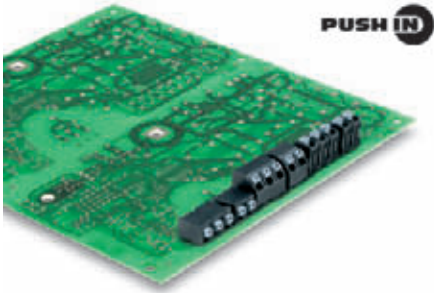

PCB terminal for fully automatic assembly in reflow soldering (SMT), with Push-In conductor connection system. Conductor inserted and slider operated in same direction (TOP). Packaged in tube or as tape on reel. Pin lengths optimised at 1.5 mm or 3.5 mm. Conductor outlet direction 135°.

- 0.20 - 1.5 mm² (IEC) / 24 - 16 AWG (UL)
- 800 V (IEC) / 300 V (UL)
- 17.5 A (IEC) / 10 A (UL)

Derating curve

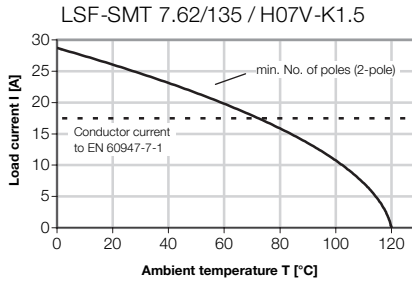

LSF-SMT 7.62/135
LSF-SMT 7.50/135

Reflow-compatible PCB terminal

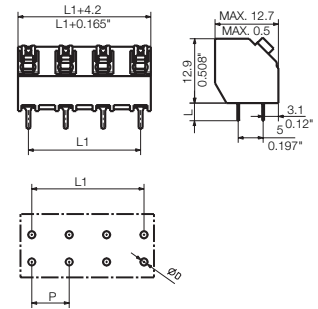

Technical data

Rated data to IEC 60664-1 / IEC 61984

Clamping range, max.	mm ²	0.13...1.5	
Solid H05(07) V-U	mm ²	0.2...1.5	
Stranded H07 V-R	mm ²		
Flexible H05(07) V-K	mm ²	0.2...1.5	
Flexible with ferrule	mm ²	0.25...1.5	
Ferrule with plastic collar	mm ²		
Stripping length	mm	8	
Screwdriver blade according to norm	mm		
Tightening torque range	Nm		

Rated current at ambient temperature		20°C	40°C
	A	17.5	17.5

Overvoltage category		III	III	II
Pollution severity		3	2	2

Rated voltage	V	500	630	800
Rated impulse voltage	kV	6	6	6

UL 1059 rated data - E60693

		B	C	D
Rated voltage	V	300	300	
Rated current	A	10	10	
AWG conductor		24-16		

CSA C22.2 rated data - LR12400 B

		B	C	D
Rated voltage	V	300	300	
Rated current	A	10	10	
AWG conductor		24-16		

Material data

Type of insulating material	LCP GF
Flammability class acc. UL94	V-0
Contact base material	Cu alloy
Material of contact surface	tinned

Information

- Rated current related to rated cross-section and min. No. of poles.
- Wire end ferrule without plastic collar to DIN 46228 pt 1
- The data given under CSA relates to a cUL approval - E60693
- P on drg. = pitch
- Hole diameter D = 1.1+0.1mm
- Operating force of slider max. 40 N
- Rated data refer only to the component itself. Clearance and creepage distances to other components are to be designed in accordance with the relevant application standards.

Ordering data

Solder pin length	1.5 mm	3.5 mm
Colour	black	black

Pitch 7.62 mm					
Poles	L1 mm	(inch)	Qty.	Order No.	Order No.
2	7.62	(0.300)	100	1884950000	1886180000
3	15.24	(0.600)	100	1884960000	1886190000
4	22.86	(0.900)	100	1884970000	1886200000
5	30.48	(1.200)	50	1884980000	1886210000
6	38.10	(1.500)	50	1884990000	1886220000
7	45.72	(1.800)	50	1885000000	1886230000
8	53.34	(2.100)	50	1885010000	1886240000

Pitch 7.50 mm					
Poles	L1 mm	(inch)	Qty.	Order No.	Order No.
2	7.50	(0.295)	100	1884880000	1886110000
3	15.00	(0.591)	100	1884890000	1886120000
4	22.50	(0.886)	100	1884900000	1886130000
5	30.00	(1.181)	50	1884910000	1886140000
6	37.50	(1.476)	50	1884920000	1886150000
7	45.00	(1.772)	50	1884930000	1886160000
8	52.50	(2.067)	50	1884940000	1886170000

LSF-SMT 7.62/135 Tape
LSF-SMT 7.50/135 Tape

Reflow-compatible PCB terminal

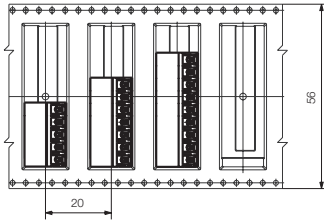

Accessories

Possible colors

Additional colours on request



Marking strips

See chapter accessories



Ordering data

Solder pin length	1.5 mm	3.5 mm
Colour	black	black

Pitch 7.62 mm

Poles	L1 mm	(inch)	Qty.	Order No.	Order No.
2	7.62	(0.300)	175	1887110000	1887160000
3	15.24	(0.600)	175	1887120000	1887170000
4	22.86	(0.900)	175	1887130000	1887180000
5	30.48	(1.200)	175	1887140000	1887190000
6	38.10	(1.500)	175	1887150000	1887200000

Pitch 7.50 mm

Poles	L1 mm	(inch)	Qty.	Order No.	Order No.
2	7.50	(0.295)	175	1888900000	1888970000
3	15.00	(0.591)	175	1888910000	1888990000
4	22.50	(0.886)	175	1888930000	1889000000
5	30.00	(1.181)	175	1888940000	1889020000
6	37.50	(1.476)	175	1888950000	1889030000

THR PCB Terminals with push-in connection

LSF-SMT 7.62/180
LSF-SMT 7.50/180

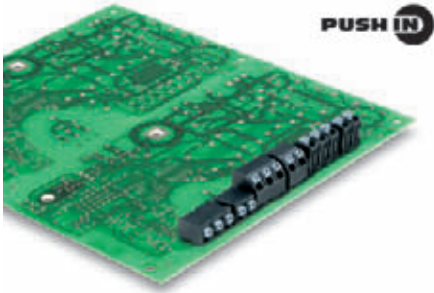

Derating curve

PCB terminal for fully automatic assembly in reflow soldering (SMT), with Push-In conductor connection system. Conductor inserted and slider operated in same direction (TOP). Packaged in tube or as tape on reel. Pin lengths optimised at 1.5 mm or 3.5 mm. Conductor outlet direction 180°.

- 0.20 - 1.5 mm² (IEC) / 24 - 16 AWG (UL)
- 800 V (IEC) / 300 V (UL)
- 17.5 A (IEC) / 10 A (UL)

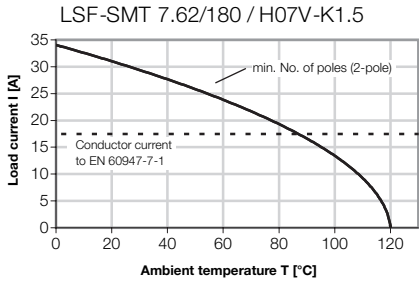

LSF-SMT 7.62/180
LSF-SMT 7.50/180

Reflow-compatible PCB terminal

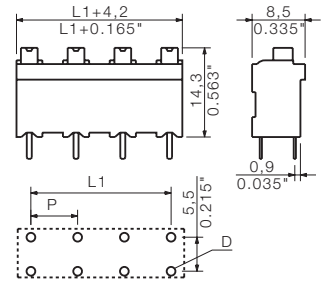
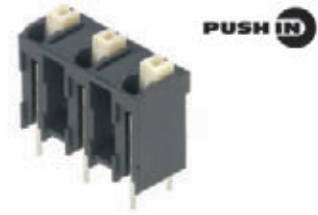

Technical data

Rated data to IEC 60664-1 / IEC 61984

Clamping range, max.	mm ²	0.13...1.5	
Solid H05(07) V-U	mm ²	0.2...1.5	
Stranded H07 V-R	mm ²		
Flexible H05(07) V-K	mm ²	0.2...1.5	
Flexible with ferrule	mm ²	0.25...1.5	
Ferrule with plastic collar	mm ²		
Stripping length	mm	8	
Screwdriver blade	mm		
according to norm			
Tightening torque range	Nm		

Rated current at ambient temperature

	A	20°C	40°C
		17.5	17.5

Overvoltage category

		III	III	II
--	--	-----	-----	----

Pollution severity

		3	2	2
--	--	---	---	---

Rated voltage	V	500	630	800
Rated impulse voltage	kV	6	6	6

UL 1059 rated data - E60693

		B	C	D
Rated voltage	V	300	150	300
Rated current	A	10	10	10
AWG conductor		24-16		

CSA C22.2 rated data - LR12400 B

		B	C	D
Rated voltage	V	300	150	300
Rated current	A	10	10	10
AWG conductor		24-16		

Material data

Type of insulating material	LCP GF
Flammability class acc. UL94	V-0
Contact base material	Cu alloy
Material of contact surface	tinned

Information

- Rated current related to rated cross-section and min. No. of poles.
- Wire end ferrule without plastic collar to DIN 46228 pt 1
- The data given under CSA relates to a cUL approval - E60693
- P on drg. = pitch
- Hole diameter D = 1.1+0.1mm
- Operating force of slider max. 40 N
- Rated data refer only to the component itself. Clearance and creepage distances to other components are to be designed in accordance with the relevant application standards.

Ordering data

Solder pin length	1.5 mm	3.5 mm
Colour	black	black

Pitch 7.62 mm

Poles	L1 mm	(inch)	Qty.	Order No.	Order No.
2	7.62	(0.300)	100	1869810000	1826210000
3	15.24	(0.600)	100	1869830000	1826220000
4	22.86	(0.900)	100	1869840000	1826230000
5	30.48	(1.200)	50	1869850000	1826240000
6	38.10	(1.500)	50	1869860000	1826250000
7	45.72	(1.800)	50	1869870000	1826260000
8	53.34	(2.100)	50	1869880000	1826270000

Pitch 7.50 mm

Poles	L1 mm	(inch)	Qty.	Order No.	Order No.
2	7.50	(0.295)	100	1870280000	1826130000
3	15.00	(0.591)	100	1870290000	1826140000
4	22.50	(0.886)	100	1870300000	1826150000
5	30.00	(1.181)	50	1870310000	1826160000
6	37.50	(1.476)	50	1870320000	1826170000
7	45.00	(1.772)	50	1870330000	1826180000
8	52.50	(2.067)	50	1870340000	1826190000

LSF-SMT 7.62/180 Tape
LSF-SMT 7.50/180 Tape

Reflow-compatible PCB terminal

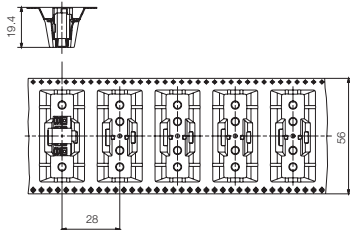

Accessories

Possible colors

Additional colours on request



Marking strips

See chapter accessories

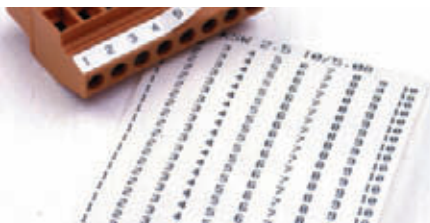

Ordering data

Solder pin length	1.5 mm	3.5 mm
Colour	black	black

Pitch 7.62 mm

Poles	L1 mm	(inch)	Qty.	Order No.	Order No.
2	7.62	(0.300)	100	1874870000	1874750000
3	15.24	(0.600)	100	1874650000	1874630000
4	22.86	(0.900)	100	1874530000	1874500000
5	30.48	(1.200)	100	1874450000	1874460000
6	38.10	(1.500)	100	1874390000	1874360000

Pitch 7.50 mm

Poles	L1 mm	(inch)	Qty.	Order No.	Order No.
2	7.50	(0.295)	100	1875500000	1875490000
3	15.00	(0.591)	100	1875460000	1875450000
4	22.50	(0.886)	100	1875090000	1875060000
5	30.00	(1.181)	100	1875010000	1875000000
6	37.50	(1.476)	100	1874950000	1874920000

